

TOFIX

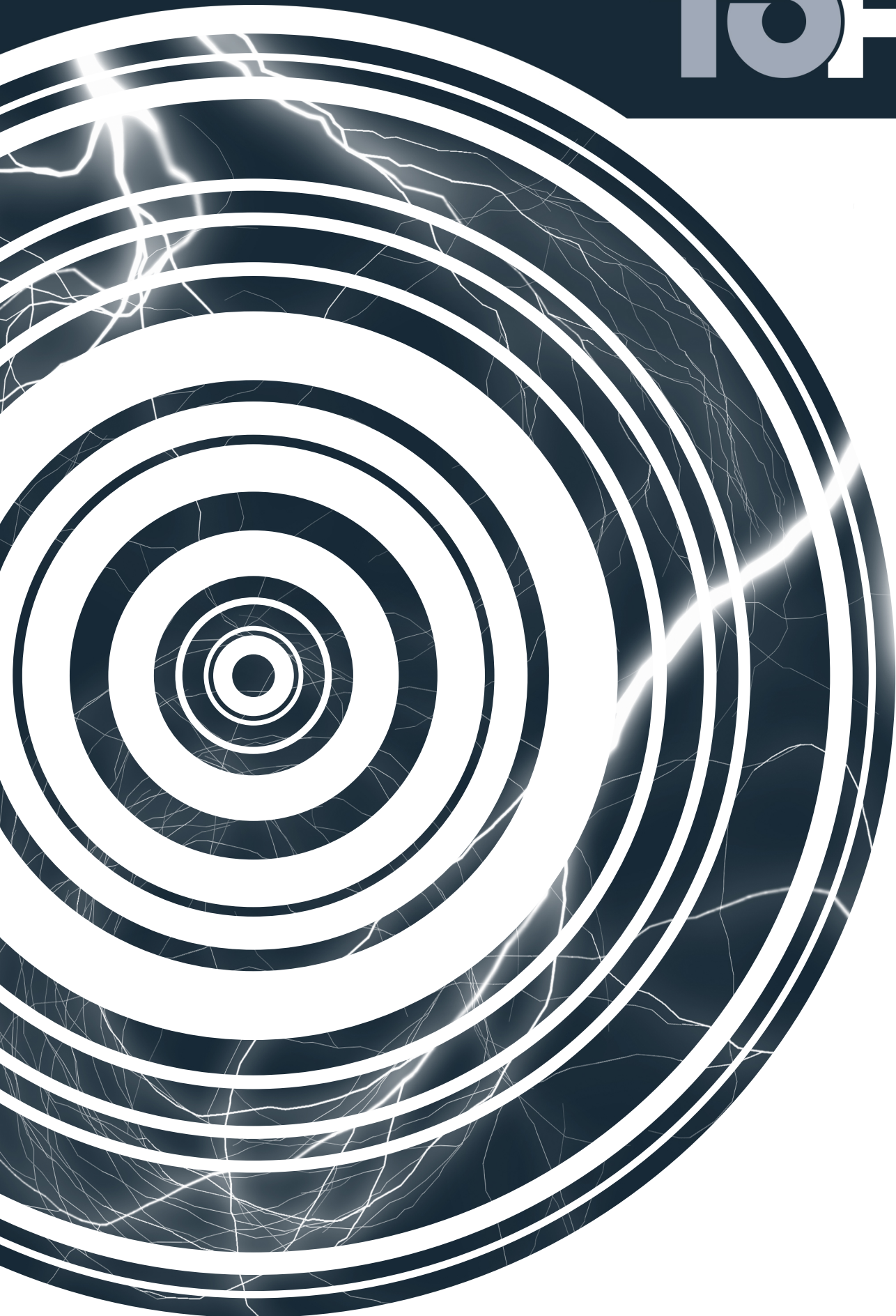

**2022 CATALOGUS
CATALOGUE**

Wandkanalen PVC White

Goulotte PVC White

BESTELNUMMER N° DE COMMANDE	Afmetingen dimensions	Lengte Longueur	VERP. EMB.
IW10054B	100 x 54 mm	2m	12 m
IW10054BEK	100 x 54 mm	1,3m*	7,8 m

RAL9003
Deksel inbegrepen
Couvercle inclus
Op aanvraag !
Sur demande !

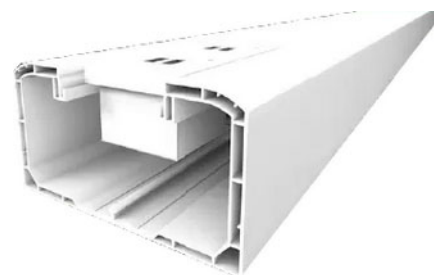

Wandkanalen PVC - Black

Goulotte PVC - Black

BESTELNUMMER N° DE COMMANDE	Afmetingen dimensions	Lengte Longueur	VERP. EMB.
IW10054Black	100 x 54 mm	2m	12 m
IW10054EKBlack	100 x 54 mm	1,3m*	7,8 m

RAL9004
Deksel inbegrepen
Couvercle inclus
Op aanvraag !
Dur demande !

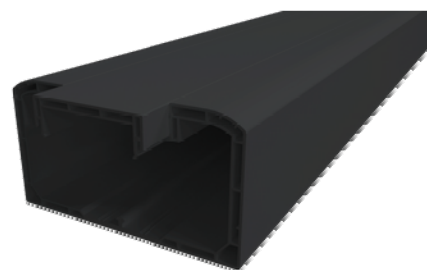

Wandkanalen LSOH

Goulotte LSOH

BESTELNUMMER N° DE COMMANDE	Afmetingen dimensions	RAL	VERP. EMB.
IW10054BLH	100 x 54 mm	RAL9003	12 m
IW10054LHBlack	100 x 54 mm	RAL9005	12 m

Deksel inbegrepen
Lengte : 2 meter
Couvercle inclus
Longueur : 2 mètres

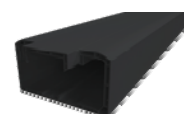
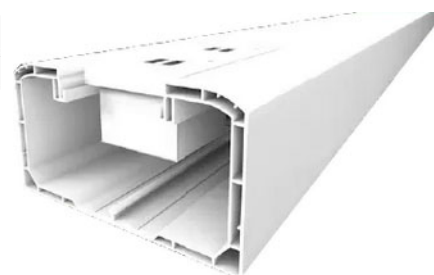

Toebehoren Wandkanalen INWAY

Accessoires Goulottes Murales INWAY

BESTELNUMMER N° DE COMMANDE	Omschr.	Descr.	VERP. EMB.
IWAE10054B	Verstelbare buitenhoek	Angle extérieur flexible	6
IWAE10054Black	Verstelbare buitenhoek	Angle extérieur flexible	6
IWAI10054B	Verstelbare binnenhoek	Angle intérieur flexible	6
IWAI10054Black	Verstelbare binnenhoek	Angle intérieur flexible	6
IWAP10054B	Vlakke hoek	Angle plat	8
IWAP10054Black	Vlakke hoek	Angle plat	8
IWGT10054B	T-stuk	Déviation-T	6
IWGT10054Black	T-stuk	Déviation-T	6
IWGU100	Verbinding voor basis en deksel	Joint pour base et couvercle	100
IWGU100Black	Verbinding voor basis en deksel	Joint pour base et couvercle	100
IWS10040B	Scheidingsshot	Séparateur	8
IWS10040Black	Scheidingsshot	Séparateur	8
IWTT10054B	Eindstuk	Embout	12
IWTT10054Black	Eindstuk	Embout	12

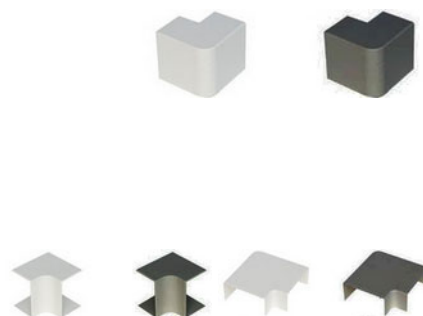

Wandkanaal

Goulotte

BESTELNUMMER N° DE COMMANDE	Afmetingen dimensions	RAL	VERP. EMB.
SYS751	75 x 50 mm	RAL 9010	24 m
SYS1252	125 x 50 mm	RAL 9010	16 m
SYS1603	160 x 50 mm	RAL 9010	12 m
SYS1051	100 x 50 mm	RAL 9010	16 m

Lengte / longueur : 2 m
 Kleur / couleur : Wit / Blanc RAL 9010
 Met deksel ! / Avec couvercle !



Deksels

Couvercles

BESTELNUMMER N° DE COMMANDE	Afmetingen dimensions	RAL	VERP. EMB.
SCO45	45 mm	RAL 9010	64 m

Lengte / longueur : 2 m
Kleur / couleur : Wit / Blanc RAL 9010

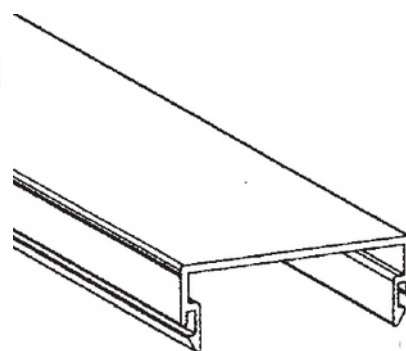

Verbindingsstuk basis

Joint de fond

BESTELNUMMER N° DE COMMANDE	VERP. EMB.
SGAC	50



Dekselverbinder

Joint de couvercle

BESTELNUMMER N° DE COMMANDE	VERP. EMB.
SGCO	20



Buithoek

Angle extérieur

BESTELNUMMER N° DE COMMANDE	Afmetingen dimensions	VERP. EMB.
LD075E	75 mm	16
LD105E	100 mm	15
LD125E	125 mm	10
SAE160	160 mm	4

CANALPLAST



Binnenhoek

Angle intérieur

BESTELNUMMER N° DE COMMANDE	Afmetingen dimensions	VERP. EMB.
LD075I	75 mm	16
LD105I	100 mm	15
LD125I	125 mm	10
SAI160	160 mm	10

CANALPLAST



Vlakke hoek

Angle plat

BESTELNUMMER N° DE COMMANDE	Afmetingen dimensions	VERP. EMB.
LD075L	75 mm	16
LD105L	100 mm	15
LD125L	125 mm	10
SAP160	160 mm	10

CANALPLAST



Vlakke hoek

Angle plat

BESTELNUMMER N° DE COMMANDE	Afmetingen dimensions	VERP. EMB.
LD075T	75 mm	12
LD105T	100 mm	15
LD125T	125 mm	10

CANALPLAST



Eindstuk

Embout

BESTELNUMMER N° DE COMMANDE	Afmetingen dimensions	VERP. EMB.
LD075A	75 mm	20
GT100A	100 mm	10
LD127A	125 mm	10
STT160	160 mm	10

CANALPLAST



Met steeklemaansluiting

Connexion automatique

BESTELNUMMER N° DE COMMANDE	Modules	Nbr. LED Aantal LED	VERP. EMB.
LG77301	1	Connexion automatique + sécurité enfant	1
LG77302	2	Connexion automatique + sécurité enfant	1
LG77303	3	Connexion automatique + sécurité enfant	1
LG77304	4	Connexion automatique + sécurité enfant	1



Met steeklemaansluiting
Connexion automatique
2-polig + aarding + kinderveiligheid
10/16 A - 250 V, Kleur : wit
2 pôles + terre + sécurité d'enfants
10/16 A - 250 V, Couleur : blanc

legrand

<45°

BESTELNUMMER N° DE COMMANDE	Modules	Fase Phase	Nbr. LED Aantal LED	VERP. EMB.
LG77142	2	2P+T	Connexion automatique - 45°+ sécurité enfant	1

Met steeklemaansluiting - 45°
Connexion automatique - 45°
10/16 A - 250 V,
Kleur : wit, Couleur : blanc
2-polig + aarding + kinderveiligheid
2 pôles + terre + sécurité d'enfants



RJ45 - CAT 6

RJ45 - CAT 6

BESTELNUMMER N° DE COMMANDE	Modules	Nbr. LED Aantal LED	VERP. EMB.
LG76561	1	RJ45 - CAT 6	1

RJ45 cat. 6 Mosaic



Geperforeerde metalen kabelbaan ineenschuifbaar

Chemin de câbles perforé emboîtable

BESTELNUMMER N° DE COMMANDE	Afmetingen dimensions	profiel	VERP. EMB.
VKKBSI60.100.075	100 x 60 mm	0,75mm	3 m
VKKBSI60.100.100	100 x 60 mm	1mm	3 m
VKKBSI 60.150.075	150 x 60 mm	0,75mm	3 m
VKKBSI 60.200.075	200 x 60 mm	0,75mm	3 m
VKKBSI60.200.100	200 x 60 mm	1mm	3 m
VKKBSI 60.250.075	250 x 60 mm	0,75mm	3 m
VKKBSI 60.300.100	300 x 60 mm	1mm	3 m
VKKBSI 60.400.100	400 x 60 mm	1mm	3 m

Hoogte / hauteur : 60 mm

Ineenschuifbare uiteinden / Extrémités emboîtables

Langs- en dwarsperforaties / Perforations perpendiculaires

Boordomslag / Bords rabattus

Op aanvraag / Sur Demande : Poedercoating - Duplex systeem /

Revêtement en poudre - Système duplex

Stand.uitv / Exec. Std : Sendzimir

Materiaal optie / Mat.Opt.1. : Hot Dip / Galvanisé à chaud

Atkore
Vergokan

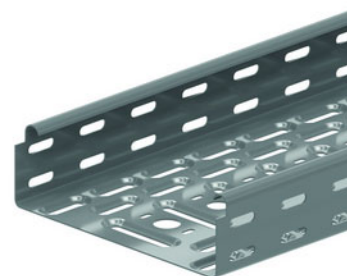

Geperforeerde metalen kabelbaan klikbaar

Chemin de câbles perforé encliquable

BESTELNUMMER N° DE COMMANDE	Afmetingen dimensions	profiel	VERP. EMB.
VKKBSCL60.100.075	100 x 60 mm	0,75mm	3 m
VKKBSCL60.100.100	100 x 60 mm	1mm	3 m
VKKBSCL 60.150.075	150 x 60 mm	0,75mm	3 m
VKKBSCL 60.200.075	200 x 60 mm	0,75mm	3 m
VKKBSCL60.200.100	200 x 60 mm	1mm	3 m
VKKBSCL60.300.075	300 x 60 mm	0,75mm	3 m
VKKBSCL 60.300.100	300 x 60 mm	1mm	3 m
VKKBSCL 60.400.100	400 x 60 mm	1mm	3 m

Hoogte / hauteur : 60 mm

Klikbaar uiteinden / Extrémités encliquable

Langs- en dwarsperforaties / Perforations perpendiculaires

Boordomslag / Bords rabattus

Op aanvraag / Sur Demande : Poedercoating - Duplex systeem /

Revêtement en poudre - Système duplex

Stand.uitv / Exec. Std : Sendzimir

Materiaal optie / Mat.Opt.1. : zinc/zink / magnesium

Atkore
Vergokan



Open ophangbeugel - Elektrolytisch verzinkt

Etrier ouvert - Electro Zingué

BESTELNUMMER N° DE COMMANDE	Afmetingen dimensions	VERP. EMB.
VKOBZ130.075	130X075 mm	12
VKOBZ130.100	130X100 mm	12
VKOBZ130.150	130X150 mm	12
VKOBZ130.200	130X200 mm	12
VKOBZ130.250	130X250 mm	6
VKOBZ130.300	130X300 mm	6
VKOBZ130.400	130X400 mm	6
VKOBZ180.075	180X075 mm	12
VKOBZ180.100	180X100 mm	12
VKOBZ180.150	180X150 mm	12
VKOBZ180.200	180X200 mm	12
VKOBZ180.250	180X250 mm	6
VKOBZ180.300	180X300 mm	6
VKOBZ180.400	180X400 mm	6

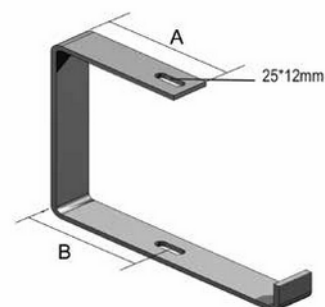

Voor bevestiging van de kabelgoot met VM6.20.
 Max. Belasting (daN): Gelijkmatic verdeeld over de volledige breedte.
 Pour la fixation d'un chemin de câble avec VM6.20.
 Charge max. (en daN): Répartie uniformément sur toute la largeur.

Geschroefde console met instelbare hoek - Elektro-verzinkt

Console ajustable - Electro Zingué

BESTELNUMMER N° DE COMMANDE	Afmetingen dimensions	VERP. EMB.
VKWKSS100	100 mm	24
VKWKSS150	150 mm	24
VKWKSS200	200 mm	24
VKWKSS250	250 mm	0
VKWKSS300	300 mm	12
VKWKSS400	400 mm	12
VKWKSS500	500 mm	6
VKWKSS600	600 mm	6

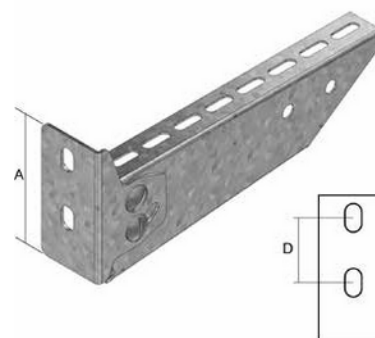

< -20° ; +40°.

Raster : 50 x 100 mm

Maille : 50 x 100 mm

BESTELNUMMER N° DE COMMANDE	Afmetingen dimensions	VERP. EMB.
VKVFUL60.100	100 x 60 mm	3 m
VKVFUL60.150	150 x 60 mm	3 m
VKVFUL60.200	200 x 60 mm	3 m
VKVFUL35.300	300 x 60 mm	3 m
VKVFUL60.400	400 x 60 mm	3 m
VKVFUL60.500	500 x 60 mm	3 m
VKVFUL35.350	350 x 60 mm	3 m

Raster/Maille : 50 x 100 mm
Dwarsdraad / Fil Transversal : 3,50 mm
Langs / Fil longitudinal : 4,50 mm

Op aanvraag / Sur Demande : Poedercoating - Duplex systeem /
Revêtement en poudre - Système duplex

Stand.uitv./Exec. Std : Elektrolytisch verzinkt / Electro Zingué
Materiaal optie / Mat.Opt.1. : Hot Dip / Galvanisé à chaud



Open ophangbeugel universeel - 290 mm - Sendzimir

Etrier ouvert universelle - 290 mm - Sendzimir

BESTELNUMMER N° DE COMMANDE	Spécificité Specificiteit	Afmetingen dimensions	VERP. EMB.
VKCOMEGACLU290.100	70 kg	290x145x145 mm	12
VKCOMEGACLU290.150	60 kg	290x194x145 mm	12
VKCOMEGACLU290.200	60 kg	290x244x145 mm	12
VKCOMEGACLU290.250	50 kg	290x294x195 mm	6
VKCOMEGACLU290.300	50 kg	290x344x195 mm	6
VKCOMEGACLU290.400	40 kg	290x444x245 mm	6



Open ophangbeugel universeel - 170 mm - Sendzimir

Etrier ouvert universelle - 170 mm - Sendzimir

BESTELNUMMER N° DE COMMANDE	Spécificité Specificiteit	Afmetingen dimensions	VERP. EMB.
VKCOMEGACLU170.150	60 kg	175x194x145 mm	12
VKCOMEGACLU170.200	60 kg	175x244x145 mm	12
VKCOMEGACLU170.300	50 kg	175x344x195 mm	6
VKCOMEGACLU170.400	40 kg	175x444x245 mm	6



Draadgoot easy Connect

Chemin de câbles en fil easy connect

BESTELNUMMER N° DE COMMANDE	Afmetingen dimensions	VERP. EMB.
EC60060EZ	60x060mm	36 / 1008 m
EC60100EZ	60x100mm	24 / 924 m
EC60150EZ	60x150mm	18 / 630 m
EC60200EZ	60x200mm	12/24/498 m
EC60300EZ	60x300mm	12 / 324 m
EC60400EZ	60x400mm	12 / 240 m
EC60500EZ	60x500mm	6 / 204 m
EC60600EZ	60x600mm	6 / 180 m
EC60100GC	60 x 100 mm	3 m



Hoogte / hauteur : 60 mm
Sendzimir
Opties / options :
a) Hot dip / galvanisé à chaud
b) Inox aisi 304
c) Inox aisi 316L



C - Beugel voor plafond

Fixation en C pour plafond

BESTELNUMMER N° DE COMMANDE	Afmetingen dimensions	VERP. EMB.
SOPC10SG	180x115x215mm	8
SOPC15SG	180x115x265mm	8
SOPC20SG	180x115x315mm	8
SOPC30SG	180x115x415mm	8



L - beugel voor Wand

Fixation en L Murale

BESTELNUMMER N° DE COMMANDE	Afmetingen dimensions	VERP. EMB.
SOC10SG	115x215mm	10
SOC15SG	115x265mm	10
SOC20SG	115x315mm	10
SOC30SG	115x415mm	10

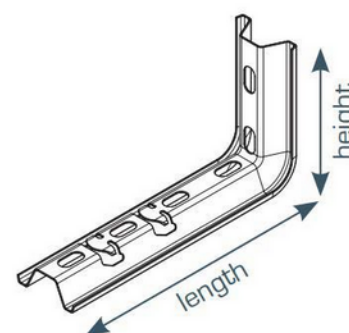

Snel Verbinder

Connecteur Rapide

BESTELNUMMER N° DE COMMANDE	Afmetingen dimensions	VERP. EMB.
MCLIC	13x23mm	100

VAIDINOX
the data for program

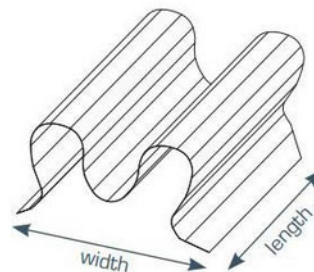

Omega-profiel zonder perforatie

Rail Omega sans perforation

BESTELNUMMER N° DE COMMANDE	Afmetingen dimensions	Lengte Longueur	VERP. EMB.
PD35Z	7,5 x 35 mm	2m	40 m
PD35CZ	15 x 35 mm	2m	20 m

Sendz.
volgens RoHS / suivant RoHS
Lengte / longueur : 2m

CANALFAST



Omega-profiel met perforatie

Rail Omega avec perforation

BESTELNUMMER N° DE COMMANDE	Afmetingen dimensions	Lengte Longueur	VERP. EMB.
PD15ZF4	15 X 55 mm	2m	100 m
PD35CZF6	15 x 35 mm	2m	20 m
PD35ZF6	7,5 x 35 mm	2m	40 m
PD32ZF6	15/6 X 32 mm*	2M	20 m

Sendz.
volgens RoHS / suivant RoHS
Lengte / longueur : 2m

CANALFAST

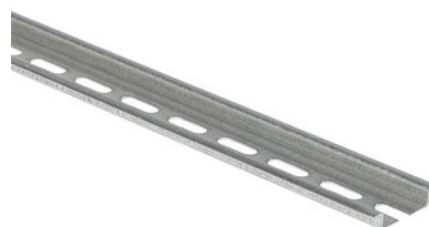

Ophangrail

Rail de suspension

BESTELNUMMER N° DE COMMANDE	Afmetingen dimensions	VERP. EMB.
9200900	15 x 30 mm	2/20 m

Sendzimir verzinkt staal/Acier galvanisé Sendzimir
Lengte/Longueur: 2m

MULLER FIX



MONTAGE PROFIEL 41X41

SYSTÈME DE MONTAGE MODULAIRE 41X41

BESTELNUMMER N° DE COMMANDE	Afmetingen dimensions	VERP. EMB.
UNP1000TX6	41X41	6m
UNP1000TX3	41X41	3m

*180 kL/r < 250

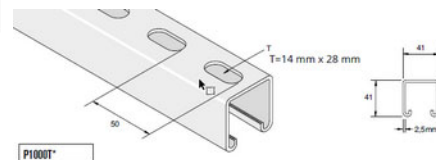

MONTAGE PROFIEL 41X21

SYSTÈME DE MONTAGE MODULAIRE 41X21

BESTELNUMMER N° DE COMMANDE	Afmetingen dimensions	VERP. EMB.
UNP3300T10X3	41X21	3m
UNP3300T10X6	41X21	6m

*180 kL/r < 250

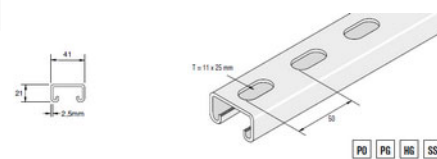

Met opening 12-8 mm

Fentes de 12-8 mm

BESTELNUMMER N° DE COMMANDE	Afmetingen dimensions	VERP. EMB.
E20	15 x 17 mm	120 m
E22	15 x 30 mm	80 m
E16	25 x 30 mm	80 m
E23	40 x 30 mm	48 m
E24	60 x 30 mm	32 m
E25	15 x 40 mm	72 m
E13	25 x 40 mm	60 m
E8	40 x 40 mm	40 m
E4	60 x 40 mm	24 m
E26	80 x 40 mm	24 m
E27	100 x 40 mm	16 m
E28	120 x 40 mm	16 m
E7	25 x 60 mm	40 m
E5	40 x 60 mm	36 m
E9	60 x 60 mm	24 m
E6	80 x 60 mm	24 m
E17	100 x 60 mm	20 m
E10	120 x 60 mm	16 m
E30	150 x 60 mm	12 m
E31	200 x 60 mm	8 m
E14	25 x 80 mm	32 m
E15	40 x 80 mm	24 m
E11	60 x 80 mm	24 m
E12	80 x 80 mm	24 m
E19	100 x 80 mm	16 m
E32	120 x 80 mm	16 m
E33	150 x 80 mm	12 m
E48	200 x 80 mm	8 m
E34	25 x 100 mm	24 m
E35	40 x 100 mm	16 m
E18	60 x 100 mm	16 m
E36	80 x 100 mm	16 m
E37	100 x 100 mm	16 m
E38	120 x 100 mm	8 m
E39	150 x 100 mm	8 m
E40	200 x 100 mm	8 m
E43	100 x 150 mm	8 m

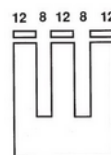

Lengte : 2 meter
 Kleur : Grijs RAL 7030
 Deksel inbegrepen
 Longueur : 2 mètres
 Couleur : Gris RAL 7030
 Couverture inclus
 Met opening / Fente 12-8 mm

CANALLAST

Met opening 6-4 mm

Fentes 6-4 mm

BESTELNUMMER N° DE COMMANDE	Afmetingen dimensions	Nbr. LED Aantal LED	VERP. EMB.
E16/4	25 x 30 mm	Avec couvercle	80 m
E13/4	25 x 40 mm	Avec couvercle	60 m
E8/4	40 x 40 mm	Avec couvercle	40 m
E4/4	60 x 40 mm	Avec couvercle	24 m
E26/4	80 x 40 mm	Avec couvercle	24 m
E7/4	25 x 60 mm	Avec couvercle	40 m
E5/4	40 x 60 mm	Avec couvercle	36 m
E9/4	60 x 60 mm	Avec couvercle	24 m
E6/4	80 x 60 mm	Avec couvercle	24 m
E17/4	100 x 60 mm	Avec couvercle	20 m
E10/4	120 x 60 mm	Avec couvercle	16 m
E14/4	25 x 80 mm	Avec couvercle	32 m
E15/4	40 x 80 mm	Avec couvercle	24 m
E11/4	60 x 80 mm	Avec couvercle	24 m
E12/4	80 x 80 mm	Avec couvercle	24 m
E19/4	100 x 80 mm	Avec couvercle	16 m
E32/4	120 x 80 mm	Avec couvercle	16 m
E34/4	25 x 100 mm	Avec couvercle	24 m
E35/4	40 x 100 mm	Avec couvercle	16 m
E18/4	60 x 100 mm	Avec couvercle	16 m
E36/4	80 x 100 mm	Avec couvercle	16 m
E37/4	100 x 100 mm	Avec couvercle	16 m



Lengte / Longueur: 2 meter / mètres
 Kleur / Couleur : Grijs / Gris RAL 7030
 Deksel inbegrepen / Couvercle inclus
 Met opening / Fente 6-4 mm

CANALAST

DIN met opening 7,5-5 mm

DIN à fentes 7,5-5 mm

BESTELNUMMER N° DE COMMANDE	Afmetingen dimensions	VERP. EMB.
ED2525	25 x 25 mm	84 m
ED2537	25 x 37,5 mm	64 m
ED3737	37,5 x 37,5 mm	48 m
ED2550	25 x 50 mm	52 m
ED3750	37,5 x 50 mm	32 m
ED5050	50 x 50 mm	24 m
ED7550	75 x 50 mm	24 m
ED10050	100 x 50 mm	16 m
ED2575	25 x 75 mm	32 m



Lengte : 2 meter
 Kleur : Grijs RAL 7030
 Deksel inbegrepen
 Longueur : 2 mètres
 Couleur : Gris RAL 7030
 Couvercle inclus
 Met opening / Fente 7-7,5 mm

CANALAST

DIN met opening 7,5-5 mm

DIN à fentes 7,5-5 mm

BESTELNUMMER N° DE COMMANDE	Afmetingen dimensions	VERP. EMB.
ED3775	37,5 x 75 mm	32 m
ED5075	50 x 75 mm	24 m
ED7575	75 x 75 mm	16 m
ED10075	100 x 75 mm	16 m
ED12575	125 x 75 mm	12 m

Lengte : 2 meter
 Kleur : Grijs RAL 7030
 Deksel inbegrepen
 Longueur : 2 mètres
 Couleur : Gris RAL 7030
 Couverture inclus
 Met opening / Fente 7-7,5 mm

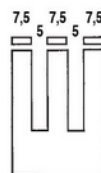

Halogeenvrije DIN met opening 7,5-5 mm

DIN à fentes 7,5-5 mm sans halogène

BESTELNUMMER N° DE COMMANDE	Afmetingen dimensions	Nbr. LED Aantal LED	VERP. EMB.
EHF2525	25 x 25 mm	Avec couvercle	84 m
EHF2537	25 x 37,5 mm	Avec couvercle	64 m
EHF2550	25 x 50 mm	Avec couvercle	52 m
EHF2575	25 x 75 mm	Avec couvercle	32 m
EHF3737	37,5 x 37,5 mm	Avec couvercle	48 m
EHF3750	37,5 x 50 mm	Avec couvercle	32 m
EHF3775	37,5 x 75 mm	Avec couvercle	32 m
EHF5050	50 x 50 mm	Avec couvercle	24 m
EHF5075	50 x 75 mm	Avec couvercle	24 m
EHF7550	75 x 50 mm	Avec couvercle	24 m
EHF7575	75 x 75 mm	Avec couvercle	16 m
EHF10050	100 x 50 mm	Avec couvercle	16 m
EHF10075	100 x 75 mm	Avec couvercle	16 m
EHF12575	125 x 75 mm	Avec couvercle	12 m

Lengte : 2 meter
 Kleur : Grijs RAL 7030
 Deksel inbegrepen
 Longueur : 2 mètres
 Couleur : Gris RAL 7030
 Couverture inclus
 Met opening / Fente 7-7,5 mm



Halogeenvrij bedradingskanaal met opening 6-6,5 mm

DIN à de 6-6,5 mm sans halogène

BESTELNUMMER N° DE COMMANDE	Afmetingen dimensions	VERP. EMB.
V6H2525	25 x 25 mm	50
V6H4025	25 x 40 mm	48
V6H4040	40 x 40 mm	50
V6H4060	60 x 40mm	50
V6H4080	80 x 40 mm	30
V6H6025	25 x 60 mm	60
V6H6040	40 x 60 mm	40
V6H6060	60 x 60 mm	24
V6H6080	80 x 60 mm	20
V6H60100	100 x 60 mm	16
V6H60120	120 X 60 mm	12
V6H8025	25 x 80 mm	20
V6H8040	40 x 80 mm	20
V6H8060	60 x 80 mm	20
V6H8080	80 x 80 mm	12
V6H80100	100 x 80 mm	12
V6H80120	120 x 80 mm	16
V6H10060	60 x 100 mm	16
V6H10080	80 x 100 mm	16
V6H100100	100 x 100 mm	12



Lengte / Longueur: 2 meter / mètres
 Kleur / Couleur : Grijs / Gris RAL 7035
 Deksel inbegrepen / Couvercle inclus
 Met opening / Fente 6-6,5 mm

arnocanali



Dwarsclips voor type E

Traverses pour type E

BESTELNUMMER N° DE COMMANDE	Afmetingen dimensions	VERP. EMB.
PTR	100 mm	25 / 100
TR06	60 mm	1
TR08	80 mm	1
TR10	100 /120 mm	1



Klinknagels en Drevel voor dito

Rivets et Chasse pour dito

BESTELNUMMER N° DE COMMANDE	Spécificité Specificiteit	Afmetingen dimensions	VERP. EMB.
RIV1	Zwart/ Noir	ø 6,5-7 mm	200
RIV2	Groen/ Vert	ø 4,5-5,5 mm	200
PRRIV1	Tool	RIV1	1
PRRIV2	Tool	RIV2	1



Kniptang voor bedradingskanalen type E

Pince pour goulottes type E

BESTELNUMMER N° DE COMMANDE	VERP. EMB.
ECUT	1



Snijmachine voor type E

Machine à couper pour goulottes type E

BESTELNUMMER N° DE COMMANDE	VERP. EMB.
WAB05200	1
ETC120	1

Maximale afmeting : 120 x 120 mm
Zowel voor PVC als HF
Dimension maximale : 120 x 120 mm
Pour PVC comme pour HF



Grijs

Gris

BESTELNUMMER N° DE COMMANDE	Afmetingen dimensions	VERP. EMB.
G16	25x30 mm	80 m
G23	40x30 mm	48 m
G24	60x30 mm	32 m
G13	25x40 mm	60 m
G8	40x40 mm	40 m
G4	60x40 mm	24 m
G26	80x40 mm	24 m
G27	100x40 mm	16 m
G28	120x40 mm	20 m
G7	25x60 mm	40 m
G5	40x60 mm	36 m
G9	60x60 mm	24 m
G6	80x60 mm	24 m
G17	100x60 mm	20 m
G10	120x60 mm	16 m
G30	150x60 mm	12 m
G31	200x60 mm	8 m
G14	25x80 mm	32 m
G15	40x80 mm	24 m
G11	60x80 mm	24 m
G12	80x80 mm	24 m
G19	100x80 mm	16 m
G32	120x80 mm	16 m
G33	150x80 mm	12 m
G48	200x80 mm	8 m
G35	40x100 mm	16 m
G18	60x100 mm	16 m
G37	100x100 mm	16 m
G38	120x100 mm	8 m
G39	150x100 mm	8 m
G40	200x100 mm	8 m
G43	100x150 mm	8 m
G50	250x70 mm	8 m



Lengte / Longueur: 2 meter / mètres
 Kleur / Couleur : Grijs / Gris RAL 7030
 Deksel inbegrepen / Couvercle inclus
 Afmetingen : B X H
 Dimensions : L X H

CANALPLAST

Type G - Wit

Type G - Blanc

BESTELNUMMER N° DE COMMANDE	Afmetingen dimensions	VERP. EMB.
G16BEU	25x30 mm	80 m
G23BEU	40x30 mm	48 m
G8BEU	40x40 mm	40 m
G4BEU	60x40 mm	24 m
G27BEU	100x40 mm	16 m
G9BEU	60x60 mm	24 m
G6BEU	80x60 mm	24 m
G17BEU	100x60 mm	20 m
G10BEU	120x60 mm	16 m
G30BEU	150x60 mm	12 m
G31BEU	200x60 mm	8 m
G50BEU	250x70 mm	8 m
G19BEU	100x80 mm	16 m
G33BEU	150x80 mm	12 m
G48BEU	200x80 mm	8 m
G40BEU	200x100 mm	8 m



Lengte : 2 meter Kleur : Wit RAL 9010

Deksel inbegrepen

Longueur : 2 mètres

Couleur : Blanc RAL 9010

Couvercle inclus

LIJST VAN DE TOEBEHOREN - ZIE WWW.GSV.BE

LISTE DES ACCESSOIRES - SUR WWW.GSV.BE

CANALPLAST

Type G - 1,3 m - Grijs

Type G - 1,3 m - Gris

BESTELNUMMER N° DE COMMANDE	Afmetingen dimensions	VERP. EMB.
G4EK	60x40 mm	15,6 m
G17EK	100x60 mm	13 m
G31EK	200x60 mm	6 m
G40EK	200X100 mm	5,2 m
G50EK	250x70 mm	5,2 m



Lengte : 1,3 meter

Kleur : Grijs RAL 7030

Deksel inbegrepen

Longueur : 1,3 mètres

Couleur : Gris RAL 7030

Couvercle inclus

Afmetingen : B X H

Dimensions : L X H

CANALPLAST

GESLOTEN KANALEN TYPE G

CANAUX FERMÉS TYPE G

Type G - 1,3 m - Wit

Type G - 1,3 m - Blanc

BESTELNUMMER N° DE COMMANDE	Afmetingen dimensions	VERP. EMB.
G31EKBEU	200x60 mm	5,2 m
G50EKBEU	250x70 mm	5,2 m
G40EKBEU	200x100 mm	5,2 m

Lengte : 1,3 meter
 Kleur : Wit RAL 9010
 Compleet met deksel
 Longueur : 1,3 mètres
 Couleur : Blanc RAL 9010
 Complet avec couvercle
 Afmetingen : B X H
 Dimensions : L X H

CANALFAST



Type G - 1,5 m - Wit

Type G - 1,5 m - Blanc

BESTELNUMMER N° DE COMMANDE	Afmetingen dimensions	VERP. EMB.
G31KBEU	200x60 mm	6 m
G50KBEU	250x70 mm	6 m

Lengte : 1,5 meter
 Kleur : Wit RAL 9010
 Compleet met deksel
 Longueur : 1,5 mètres
 Couleur : Blanc RAL 9010
 Complet avec couvercle
 Afmetingen : B X H
 Dimensions : L X H

CANALFAST



Deksels voor type E en G Grijs

Couvercles pour type E et G Gris

BESTELNUMMER N° DE COMMANDE	Afmetingen dimensions	Lengte Longueur
GCOP025	25 mm	2 m
GCOP040	40 mm	2 m
GCOP060	60 mm	2 m
GCOP080	80 mm	2 m
GCOP100	100 mm	2 m
GCOP120	120 mm	2 m
GCOP150	150 mm	2 m
GCOP200	200 mm	2 m

Lengte / longueur : 2 m
 Kleur / couleur : Grijs / gris RAL 7030

CANALFAST



Deksels voor type G Wit

Couvercles pour type G Blanc

BESTELNUMMER N° DE COMMANDE	Afmetingen dimensions	Lengte Longueur
GCOP100BEU	100 mm	2 m
GCOP120BEU	120 mm	2 m
GCOP150BEU	150 mm	2 m
GCOP200BEU	200 mm	2 m

RAL 9010

CANALLAST



Kabelhouders voor type E en G

Clips de câble pour type E et G

BESTELNUMMER N° DE COMMANDE	Afmetingen dimensions	VERP. EMB.
FCV12040	40/120x40 mm	100
FCV12060	40/200x60 mm	100

CANALLAST



Scheidingschotten voor type E en G

Séparations pour type E et G

BESTELNUMMER N° DE COMMANDE	Afmetingen dimensions	Lengte Longueur	VERP. EMB.
S1	40 mm	2 m	60 m
S2	60 mm	2 m	50 m
S4	80 mm		32 m
S5	100 mm		32 m

Lengte / Longueur 2m

CANALLAST



Vloerkanalen

Canaux de sol

BESTELNUMMER N° DE COMMANDE	Spécificité Specificiteit	Afmetingen dimensions	VERP. EMB.
ZBFG		75 x 16 mm	40 m
ZBFG-M	*	50 x 12 mm	60 m
ZBFB		75 x 16 mm	40 m

Lengte / Longueur : 2 m
 ZBFG : Couleur/Couleur = grijs/gris
 ZBFB : Couleur/Couleur = wit/blanc
 *FINAL STOCK

CANALPLAST



Zelfklevende minikanalen

Canaux mini autoadhésifs

BESTELNUMMER N° DE COMMANDE	Afmetingen dimensions	VERP. EMB.
J1207PAD	12 x 7 mm	160 m
J1610PAD	16 x 10 mm	90 m

Lengte / longueur : 2 m
Kleur / couleur : Wit / Blanc
Met clic-deksel / Avec couvercle clic



Minikanalen type BS

Canaux mini type BS

BESTELNUMMER N° DE COMMANDE	Afmetingen dimensions	VERP. EMB.
BS11BEU	16 x 16 mm	92 m
BS21BEU	25 x 16 mm	72 m
BS61BEU	60 x 16 mm	36 m

Deksel inbegrepen
Lengte : 2 meter
Couvercle inclus
Longueur : 2 mètres



TYPE G

TYPE G

BESTELNUMMER N° DE COMMANDE	Afmetingen dimensions	RAL	VERP. EMB.
G20BEU	15 x 18 mm	RAL 9010	120 m
G41BEU	20 x 10 mm	RAL 9010	120 m
G44BEU	25 x 20 mm	RAL 9010	60 m
G45BEU	40 x 20 mm	RAL 9010	42 m

Deksel inbegrepen
Lengte : 2 meter
Couvercle inclus
Longueur : 2 mètres
Wit - Blanc



Blisterverpakking met toebehoren voor de G20BEU

Blister d'accessoires pour G20BEU

BESTELNUMMER N° DE COMMANDE	Omschr.	Descr.	Afmetingen dimensions	VERP. EMB.
20BLI	Set voor G20B*	Set pour G20B*	15 x 18 mm	1

20BLI = Blisterverpakking met toebehoren voor de G20B met : 1 Buitenhoek + 1

Binnenhoek + 2 Vlakke hoeken + 1 T-stuk + 1 Koppeling + 1 Eindstuk

20BLI = Emballage blister avec les accessoires pour la G20B incluant : 1 Angle extérieur
+ 1 Angle intérieur + 2 Angles plat + 1 Déviation-T + 1 Raccord + 1 Embout

Buitenhoek

Angle extérieur

BESTELNUMMER N° DE COMMANDE	Omschr.	Descr.	Afmetingen dimensions	VERP. EMB.
41E	Buitenhoek	Angle Extérieur	20 x 10 mm	10
44E	Buitenhoek	Buitenhoek	25 x 20 mm	5
GT248EB	Buitenhoek	Buitenhoek	40 x 20 mm	5



Vlakke hoek

Angle plat

BESTELNUMMER N° DE COMMANDE	Omschr.	Descr.	Afmetingen dimensions	VERP. EMB.
41L	Vlakke Hoek	Angle Extérieur	20 x 10 mm	10
44L	Vlakke Hoek	Angle Extérieur	25 x 20 mm	5
GT248LB	Vlakke Hoek	Angle Extérieur	40 x 20 mm	5
GT248IB	Binnenhoek	Angle intérieur	40 x 20 mm	5
41I	Binnenhoek	Angle intérieur	20 x 10 mm	10



T-stuk

Déviation-T

BESTELNUMMER N° DE COMMANDE	Omschr.	Descr.	Afmetingen dimensions	VERP. EMB.
41T	T Stuk	Dérivation T	20 x 10 mm	10
44T	T Stuk		25 x 20 mm	5
GT248TB	T Stuk	Dérivation T	40 x 20 mm	5



Koppeling

Raccord

BESTELNUMMER N° DE COMMANDE	Omschr.	Descr.	Afmetingen dimensions	VERP. EMB.
41G	Koppelstuk	Raccord	20 x 10 mm	10
44G	Koppelstuk	Raccord	25 x 20 mm	5
GT248GB	Koppelstuk	Raccord	40 x 20 mm	5



Eindstuk voor G MINI

Embout pour G MINI

BESTELNUMMER N° DE COMMANDE	Omschr.	Descr.	Afmetingen dimensions	VERP. EMB.
41S	Eindstuk	Embout	20 x 10 mm	10
GT16A	Eindstuk	Embout	25 x 20 mm	5
GT248AB	Eindstuk	Embout	40 x 20 mm	5



TYPE INWAY

TYPE INWAY

BESTELNUMMER N° DE COMMANDE	Afmetingen dimensions	RAL	VERP. EMB.
IW2012.5B	20 x 12,5 mm	RAL 9010	80m
IW4017B	40 X 17 mm	RAL 9010	32m

Deksel inbegrepen
 Lengte : 2 meter
 Couvercle inclus
 Longueur : 2 mètres



Mini Inway - Toebehoren

Mini Inway - Accessoires



BESTELNUMMER N° DE COMMANDE	Omschr.	Descr.	Afmetingen dimensions
IWAE2012B	Buitenhoek	Angle extérieur	20 x 12,5 mm
IWAE4017B	Buitenhoek	Angle extérieur	40 x 17 mm
IWAI2012B	Binnenhoek	Angle intérieur	20 x 12,5 mm
IWAI4017B	Binnenhoek	Angle intérieur	40 x 17 mm
IWAP2012B	Vlakke hoek	Angle Plat	20 x 12,5 mm
IWAP4017B	Vlakke hoek	Angle Plat	40 x 17 mm
IWGT2012B	T	Dérivation "T"	20 x 12,5 mm
IWGT4017B	T	Dérivation "T"	40 x 17 mm
IWGU2012B	Koppelstuk	Joint	20 x 12,5 mm
IWGU4017B	Koppelstuk	Joint	40 x 17 mm
IWTT2012B	Eindstuk	Embout	20 x 12,5 mm
IWTT4017B	Eindstuk	Embout	40 x 17 mm



TYPE INWAY BLACK

TYPE INWAY BLACK

BESTELNUMMER N° DE COMMANDE	Afmetingen dimensions	RAL	VERP. EMB.
IW2012.5Black	20 X 12,5 mm	RAL 9005	80 m
IW4017Black	40 x 17 mm	RAL 9005	30 m

Deksel inbegrepen

Lengte : 2 meter

Couvercle inclus

Longueur : 2 mètres

EXTRA: op aanvraag verkrijgbaar in halogeenvrije uitvoering

EXTRA: sur demande disponible en version sans halogène



Mini Inway Black - Toebehoren

Mini Inway Black - Accessoires

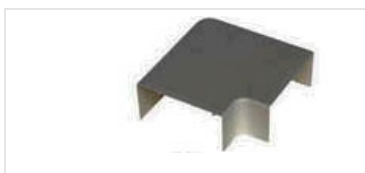

BESTELNUMMER N° DE COMMANDE	Omschr.	Descr.	Afmetingen dimensions
IWAE2012Black	Buitenhoek	Angle extérieur	20 x 12,5 mm
IWAE4017Black	Buitenhoek	Angle extérieur	40 x 17 mm
IWAI2012Black	Binnenhoek	Angle intérieur	20 x 12,5 mm
IWAI4017Black	Binnenhoek	Angle intérieur	40 x 17 mm
IWAP2012Black	Vlakke hoek	Angle Plat	20 x 12,5 mm
IWAP4017Black	Vlakke hoek	Angle Plat	40 x 17 mm
IWGT2012Black	"T" stuk	Dérivation "T"	20 x 12,5 mm
IWGT4017Black	"T" stuk	Dérivation "T"	40 x 17 mm
IWGU2012Black	Koppelstuk	Joint	20 x 12,5 mm
IWGU4017Black	Koppelstuk	Joint	40 x 17 mm
IWTT2012Black	Eindstuk	Embout	20 x 12,5 mm
IWTT4017Black	Eindstuk	Embout	40 x 17 mm



TYPE INWAY LSOH

TYPE INWAY LSOH

BESTELNUMMER N° DE COMMANDE	Afmetingen dimensions	RAL	VERP. EMB.
IW20125LH	20 x 12,5 mm	RAL 9010	80m
IW2020LH	20 x 20 mm	RAL 9010	50m
IW4017LH	40 X 17 mm	RAL 9010	30m
IW6040LH	60 x 40 mm	RAL 9010	32m

Deksel inbegrepen
Lengte : 2 meter
Couvercle inclus
Longueur : 2 mètres



TYPE INWAY BLACK LSOH

TYPE INWAY BLACK LSOH

BESTELNUMMER N° DE COMMANDE	Afmetingen dimensions	RAL	VERP. EMB.
IW2012.5LHBlack	20 X 12,5 mm	RAL 9005	80 m
IW4017LHBlack	40 x 17 mm	RAL 9005	30 m

Deksel inbegrepen
Lengte : 2 meter
Couvercle inclus
Longueur : 2 mètres
EXTRA: op aanvraag verkrijgbaar in halogeenvrije uitvoering
EXTRA: sur demande disponible en version sans halogène



LHD

LHD

BESTELNUMMER N° DE COMMANDE	Afmetingen dimensions	RAL	VERP. EMB.
LHD2010HF	20 x 10 mm	RAL 9003	96 m
LHD2020HF	20 x 20 mm	RAL 9003	48 m
LHD4020HF	40 x 20 mm	RAL 9003	24 m
LHD4040HF	40 x 40 mm	RAL 9003	20 m

Deksel inbegrepen
Lengte : 2 meter
Couvercle inclus
Longueur : 2 mètres



Buitenhoek

Angle extérieur

BESTELNUMMER N° DE COMMANDE	Afmetingen dimensions	VERP. EMB.
LHD8926HF	20 x 10 mm	1/10
LHD8626HF	20 x 20 mm	1/10
LHD8636HF	40 x 20 mm	1/10
LHD8646HF	40 x 40 mm	1/10

KOPOS



Binnenhoek

Angle intérieur

BESTELNUMMER N° DE COMMANDE	Afmetingen dimensions	VERP. EMB.
LHD8925HF	20 x 10 mm	1/10
LHD8625HF	20 x 20 mm	1/10
LHD8635HF	40 x 20 mm	1/10
LHD8645HF	40 x 40 mm	1/10
SAI160BEU	160 mm	1/10

KOPOS



Vlakke hoek

Angle plat

BESTELNUMMER N° DE COMMANDE	Afmetingen dimensions	VERP. EMB.
LHD8923HF	20 x 10 mm	1/10
LHD8623HF	20 x 20 mm	1/10
LHD8633HF	40 x 20 mm	1/10
LHD8643HF	40 x 40 mm	1/10

KOPOS



T-stuk

Déviation-T

BESTELNUMMER N° DE COMMANDE	Afmetingen dimensions	VERP. EMB.
LHD8924HF	20 x 10 mm	1/10
LHD8624HF	20 x 20 mm	1/10
LHD8634HF	40 x 20 mm	1/10
LHD8644HF	40 x 40 mm	1/10



Kanalen voor Airco - Wit

Canaux pour Air Conditionné Blanc

BESTELNUMMER N° DE COMMANDE	Afmetingen dimensions	VERP. EMB.
CON30	35 x 30 mm	64 m
CON70	70 x 55 mm	24 m
CON90	90 x 65 mm	16 m
CON125	125 x 75 mm	8 m

Deksel inbegrepen Lengte : 2 meter Kleur : Wit RAL 9010
 Couverture inclus Longueur : 2 mètres Couleur : Blanc RAL 9010
 Lijst met referenties verkrijgbaar op aanvraag.
 La liste avec les références est disponible sur demande.



Kanalen voor Airco - Bruin

Canaux pour Air Conditionné Brun

BESTELNUMMER N° DE COMMANDE	Afmetingen dimensions	VERP. EMB.
CON30M	35 x 30 mm	64 m
CON70M	70 x 55 mm	24 m
CON90M	90 x 65 mm	16 m
CON125M	125 x 75 mm	8 m

Deksel inbegrepen Lengte : 2 meter Kleur : Bruin RAL 8017
 Couverture inclus Longueur : 2 mètres Couleur : Marron RAL 8017
 Lijst met referenties verkrijgbaar op aanvraag.
 La liste avec les références est disponible sur demande.



Isolatietape 0,15 mm x 19 mm x 20 m

Ruban isolant 0,15 mm x 19 mm x 20 m

BESTELNUMMER N° DE COMMANDE	Kleur	Couleur	Temp.couleur Kleur Temp.	VERP. EMB.
TP151920BK	zwart	noir	1	10 / 250
TP151920BL	blauw	bleu	1	10 / 250
TP151920BN	bruin	brun	1	10 / 250
TP151920GRN	groen	vert		10 / 250
TP151920GY	groen-geel	vert-jaune	1	10 / 250
TP151920RD	rood	rouge	1	10 / 250
TP151920WT	wit	blanc	1	10 / 250
TP151920YL	geel	jaune	1	10 / 250
TP151920GR	grijs	gris	1	10 / 250

Vlamvertragend BSEN 60454-2
Flame retardant BSEN 60454-2



Universele steekklemmen

Raccords câble à juxtaposer universels

BESTELNUMMER N° DE COMMANDE	VERP. EMB.
SDKF2TR-AN	100 / 2000
SDKF3TR-AN	75 / 1500
SDKF5TR-AN	50 / 1000

Voor kabel 0,2 à 2,5 mm²
Pour câble 0,2 à 2,5 mm²



Stekklemmen voor een harde draad

Raccords câble à juxtaposer pour fil rigide

BESTELNUMMER N° DE COMMANDE	VERP. EMB.
SDK3	100 / 2000
SDK5	100 / 2000
SDK8	100 / 1000

Voor kabel 1 à 2,5 mm²
Pour câble 1 à 2,5 mm²



Lusterklemmen

Raccords lustre

BESTELNUMMER N° DE COMMANDE	ø	Temp.couleur Kleur Temp.	VERP. EMB.
50704	2,5 - 4 mm ²	1	10/500
50706	6 mm ²	1	10/250
50710	10 mm ²	1	10/250
50716	16 mm ²	1	10/100
50725	25 mm ²	1	10/50

12 polen per strip
12 pôles par barrette
PVC transparent



Klemstenen

Barrettes de connection

BESTELNUMMER N° DE COMMANDE	Spécificité Specificiteit	VERP. EMB.
397-5	*1	20
397-3A	*1	20
398-5	*2	20
399-5	*3	10

*1 Voor montage in dozen / Pour montage en boîtes : 220A / 220B / 222A / 222B / 222L

*2 Voor montage in dozen / Pour montage en boîtes : FE25 / FE7 / FE12

*3 Voor montage in dozen / Pour montage en boîtes : BOX LINE

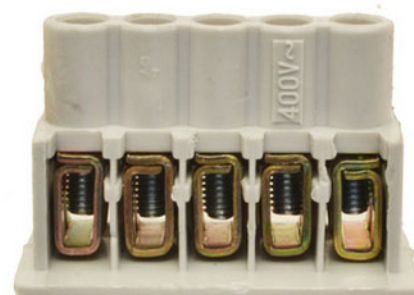

Kabelbinders wit A

Colliers de câblage blancs A

BESTELNUMMER N° DE COMMANDE	Afmetingen dimensions	VERP. EMB.
SEL2142	550 x 9,0	100 / 700
SEL2143	780 x 9,0	100 / 500
SEL2144	430 x 9,0	100 / 1000
SEL2155	1220 x 9,0	100 / 500
SEL2201	75 x 2,5	100 / 5000
SEL2202	100 x 2,5	100 / 5000
SEL2203	135 x 2,5	100 / 5000
SEL2204	160 x 2,5	100 / 5000
SEL2205	200 x 2,5	100 / 5000
SEL2210	140 x 3,5	100 / 5000
SEL2211	200 x 3,5	100 / 5000
SEL2212	280 x 3,5	100 / 5000
SEL2214	360 x 3,5	100 / 4000
SEL2216	250 x 3,5	100 / 5000
SEL2220	140 x 4,5	100 / 5000
SEL2221	160 x 4,5	100 / 5000
SEL2222	180 x 4,5	100 / 5000
SEL2223	200 x 4,5	100 / 5000
SEL2224	250 x 4,5	100 / 5000
SEL2425	280 x 4,5	100 / 5000
SEL2426	360 x 4,5	100 / 4000
SEL2427	380 x 4,5	100 / 3500
SEL2428	430 x 4,5	100 / 2500
SEL2429	300 x 4,5	100 / 4000
SEL2430	180 x 7,5	100 / 2500
SEL2431	240 x 7,5	100 / 2000
SEL2432	200 x 7,5	100 / 5000
SEL2433	280 x 7,5	100 / 2000
SEL2434	360 x 7,5	100 / 1500
SEL2435	450 x 7,5	100 / 2500
SEL2436	500 x 7,5	100 / 1000
SEL2438	320 x 7,5	100 / 1500
SEL2441	750 x 7,5	100 / 700
SEL2447	360 X 6,0	50 / 500
SEL2450	250 x 12,5	50 / 500
SEL2451	500 x 12,5	50 / 500
SEL2452	750 x 12,5	50 / 500
SEL2453	1000 x 12,5	50 / 500
SEL3215	225 x 3,5	100 / 5000
SEL3437	540 x 7,5	100 / 2500



Nylon PA 6.6



Kabelbinders zwart A

Colliers de câblage noirs A

BESTELNUMMER N° DE COMMANDE	Afmetingen dimensions	VERP. EMB.
SEL3142	550 x 9,0	100 / 700
SEL3143	780 x 9,0	100 / 500
SEL3144	430 x 9,0	100 / 1000
SEL3150	250 x 12,5	50 / 500
SEL3155	1220 x 9,0	100 / 500
SEL3201	75 x 2,5	100 / 5000
SEL3202	100 x 2,5	100 / 5000
SEL3203	135 x 2,5	100 / 5000
SEL3204	160 x 2,5	100 / 5000
SEL3205	200 x 2,5	100 / 5000
SEL3210	140 x 3,5	100 / 5000
SEL3211	200 x 3,5	100 / 5000
SEL3212	280 x 3,5	100 / 5000
SEL3214	360 x 3,5	100 / 4000
SEL3216	250 x 3,5	100 / 5000
SEL3220	140 x 4,5	100 / 5000
SEL3221	160 x 4,5	100 / 5000
SEL3222	180 x 4,5	100 / 5000
SEL3223	200 x 4,5	100 / 5000
SEL3224	250 x 4,5	100 / 5000
SEL3425	280 x 4,5	100 / 5000
SEL3426	360 x 4,5	100 / 4000
SEL3427	380 x 4,5	100 / 3500
SEL3428	430 x 4,5	100 / 2500
SEL3429	300 x 4,5	100 / 4000
SEL3430	180 x 7,5	100 / 2500
SEL3431	240 x 7,5	100 / 2000
SEL3432	200 X 7,5	100 / 5000
SEL3433	280 x 7,5	100 / 2000
SEL3434	360 x 7,5	100 / 1500
SEL3436	500 x 7,5	100 / 1000
SEL3438	320 x 7,5	100 / 1500
SEL3441	750 x 7,5	100 / 700
SEL3447	360 x 6,0	100 / 1500
SEL3451	500 x 12,5	50 / 500
SEL3452	750 x 12,5	50 / 500
SEL3453	1000 x 12,5	50 / 500

Nylon PA 6.6



Kabelbinders wit B

Colliers de câblage blancs B

BESTELNUMMER N° DE COMMANDE	Afmetingen dimensions	VERP. EMB.
MF10025	100 x 2,5 mm	100 / 55000
MF15025	150 x 2,5 mm	100 / 20000
MF15035	150 x 3,5 mm	100 / 10000
MF15045	150 x 4,5 mm	100 / 10000
MF20025	200 x 2,5 mm	100 / 32000
MF20048	200 x 4,8 mm	100 / 16000
MF30036	300 x 3,6 mm	100 / 17000
MF30048	300 x 4,8 mm	100 / 11000
MF37048	370 x 4,8 mm	100 / 9000
MF30076	300 x 7,6 mm	100 / 5000
MF37076	370 x 7,6 mm	100 / 4000
MF53076	530 x 7,6 mm	100 / 2000
MF53090	530 x 9,0 mm	100 / 1500
MF76090	760 x 9,0 mm	100 / 1200
MF116890	1168 x 9,0 mm	100 / 1000

Nylon PA 6.6

MULLER FIX

Kabelbinders zwart B

Colliers de câblage noirs B

BESTELNUMMER N° DE COMMANDE	Afmetingen dimensions	VERP. EMB.
MF10025B	100 x 2,5 mm	100 / 55000
MF15025B	150 x 2,5 mm	100 / 20000
MF15035B	150 x 3,5 mm	100 / 10000
MF15045B	150 x 4,5 mm	100 / 10000
MF20025B	200 x 2,5 mm	100 / 32000
MF20048B	200 x 4,8 mm	100 / 16000
MF30036B	300 x 3,6 mm	100 / 17000
MF30048B	300 x 4,8 mm	100 / 11000
MF37048B	370 x 4,8 mm	100 / 9000
MF30076B	300 x 7,6 mm	100 / 5000
MF37076B	370 x 7,6 mm	100 / 4000
MF53076B	530 x 7,6 mm	100 / 2000
MF53090B	530 x 9,0 mm	100 / 1500
MF76090B	760 x 9,0 mm	100 / 1200
MF116890B	1168 x 9,0 mm	100 / 1000

Nylon PA 6.6

MULLER FIX



Pluggen voor kabelbinders

Chevilles pour colliers de serrage

BESTELNUMMER N° DE COMMANDE	Temp.couleur Kleur Temp.	VERP. EMB.
MF111	1	100 / 3500

Plug voor kabelbinders tot 9 mm breed
Cheville pour colliers de serrage jusqu'à 9 mm de largeur
Nylon PA 6.6



Basis zwart voor kabelbinders

Base noir pour colliers de serrage

BESTELNUMMER N° DE COMMANDE	VERP. EMB.
MF112	100 / 9600

Plug voor kabelbinders tot 9 mm breed
Cheville pour colliers de serrage jusqu'à 9 mm de largeur
Nylon PA 6.6



Nylon binder met inox tand - naturel

Colliers en nylon avec dent en acier inox - naturel

BESTELNUMMER N° DE COMMANDE	Afmetingen dimensions	VERP. EMB.
MET22102R	100 x 2,5	100
MET22105R	200 x 2,5	100
MET22110R	140 x 3,5	100
MET22111R	200 x 3,5	100
MET22112R	280 x 3,5	100
MET22123R	200 x 4,5	100
MET22126R	360 x 4,5	100
MET22140R	290 x 4,5	100
MET22534R	360 x 7,5	100

Nylon PA 6.6



Nylon binder met inox tand - Zwart

Colliers en nylon avec dent en acier inox - Noir

BESTELNUMMER N° DE COMMANDE	Afmetingen dimensions	VERP. EMB.
MET32102R	100 x 2,5	100
MET32105R	200 x 2,5	100
MET32110R	140 x 3,5	100
MET32111R	200 x 3,5	100
MET32112R	280 x 3,5	100
MET32123R	200 x 4,5	100
MET32126R	360 x 4,5	100
MET32140R	290 x 4,5	100
MET32326R	360 X 4,5	100
MET32534R	360 x 7,5	100

Nylon PA 6.6



Herbruikbare Click Tie - Rood

Collier Ré Ouvrable - Rouge

BESTELNUMMER N° DE COMMANDE	Afmetingen dimensions	VERP. EMB.
CLT102110R	120 x 3,5	100 / 5000
CLT102116R	240 x 3,8	100 / 5000
CLT102129R	320 x 4,4	100 / 5000
CLT102149R	500 x 5,6	100 / 5000

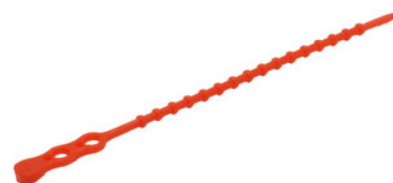

Kabelbinders gekleurd

Colliers de câblage colorés

BESTELNUMMER N° DE COMMANDE	Afmetingen dimensions	Kleur	Couleur	VERP. EMB.
SEL10202R	100 x 2,5	Rood	Rouge	100 / 5000
SEL10210R	140 x 3,5	Rood	Rouge	100 / 5000
SEL10223R	200 x 4,5	Rood	Rouge	100 / 5000
SEL10425R	280 x 4,5	Rood	Rouge	100 / 5000
SEL11202R	100 x 2,5	Blauw	Bleu	100 / 5000
SEL11210R	140 x 3,5	Blauw	Bleu	100 / 5000
SEL11223R	200 x 4,5	Blauw	Bleu	100 / 5000
SEL11425R	280 x 4,5	Blauw	Bleu	100 / 5000
SEL12202R	100 x 2,5	Groen	Vert	100 / 5000
SEL12210R	140 x 3,5	Groen	Vert	100 / 5000
SEL12223R	200 x 4,5	Groen	Vert	100 / 5000
SEL12425R	280 x 4,5	Groen	Vert	100 / 5000
SEL14202R	100 x 2,5	Geel	Jaune	100 / 5000
SEL14210R	140 x 3,5	Geel	Jaune	100 / 5000

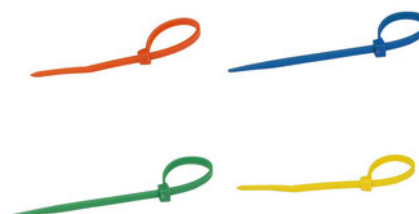

Kabelbinders gekleurd

Colliers de câblage colorés

BESTELNUMMER N° DE COMMANDE	Afmetingen dimensions	Kleur	Couleur	VERP. EMB.
SEL14223R	200 x 4,5	Geel	Jaune	100 / 5000
SEL14425R	280 x 4,5	Geel	Jaune	100 / 5000

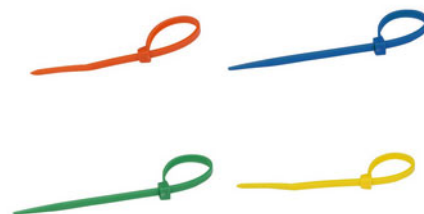

Inox kabelbinders

Colliers de câblage en inox

BESTELNUMMER N° DE COMMANDE	Afmetingen dimensions	Temp.couleur Kleur Temp.	VERP. EMB.
SSCT1	150x4.6	1	100
SSCT2	200x4.6	1	100
SSCT6	300x4.6	1	100
SSCT3	360x4.6	1	100
SSCT4	520x4.6	1	100
SSCT5	360x7.9	1	100
SSCT7	520x7.9	1	100



Spantangen

Pinces à sertir

BESTELNUMMER N° DE COMMANDE	Spécificité Specificiteit	Temp.couleur Kleur Temp.	VERP. EMB.
PIN003-CTTN	*1		1
PIN006-CTTS	*2	1	1

*1

Tang in metaal - Spantang tot 4,8 mm voor nylon - Snijdt zonder braam.

Pince en métal - Pince à serrage pour nylon jusqu'à 4,8 mm - Coupe sans morfil.

*2

Tang in metaal. Spantang tot 7,9 mm voor metalen kabelbinders - Snijdt zonder braam.

Pince en métal - Pince à serrage pour colliers en métal jusqu'à 7,9 mm - Coupe sans morfil.



Identificatieplaatje

Plaquette d'identification

BESTELNUMMER N° DE COMMANDE	Afmetingen dimensions	VERP. EMB.
SEL101	20x40x1,3mm	100 / 3000



Zelfklevende 2-weg console

Console adhésive double direction

BESTELNUMMER N° DE COMMANDE	Afmetingen dimensions	VERP. EMB.
SEL2501	ø 20 mm	100 / 3000
SEL2502	ø 28 mm	100 / 3000



Klipconsoles 'Hooks' zelfklevend

Consoles clips 'Hooks' adhésifs

BESTELNUMMER N° DE COMMANDE	Afmetingen dimensions	VERP. EMB.
SEL2401	10 x 19	100 / 3000
SEL2402	13 x 26	100 / 3000
SEL2403	18 x 26	100 / 3000



Centuring kabelbinders

Colliers de câblage Centuring

BESTELNUMMER N° DE COMMANDE	Afmetingen dimensions	VERP. EMB.
SEL3320	180 x 9	100 / 3500
SEL3321	265 x 9	100 / 2000
SEL3322	360 x 9	100 / 1400
SEL3323	500 x 9	100 / 1000
SEL3324	750 x 9	100 / 1000

Polyamide 12



Spantang voor Centuring

Pince à sertir pour Centuring

BESTELNUMMER N° DE COMMANDE	∅	VERP. EMB.
PIN005	∅	1



Kabelstrip wit - met markeerplaat 8 x 25 mm

Collier blanc - avec plaquette d'identification 8 x 25 mm

BESTELNUMMER N° DE COMMANDE	Afmetingen dimensions	VERP. EMB.
SEL.2.202T	100 x 2,5	100 / 5000

Nylon PA 6.6



Universele nagelclips

Clips à clouer universels

BESTELNUMMER N° DE COMMANDE	ø	VERP. EMB.
700/02	ø 2,5 - 4 mm	100
700/05	ø 5 - 7 mm	100
700/08	ø 8 - 10 mm	100
700/11	ø 11 - 15 mm	100 / 1000
700/16	ø 16 - 19 mm	50 / 500
700/23	ø 23 - 29 mm	50 / 250
700-08 Black	8 - 10 mm *	100 / 9600

Met slechts 5 types alle maten in voorraad.
Avec seulement 5 types toutes dimensions en stock
* Black



Nagelclips - maten in mm

Attaches à clouer - mesures en mm

BESTELNUMMER N° DE COMMANDE	Afmetingen dimensions	VERP. EMB.
3004/18	ø 4 mm	100 / 12800
3005/18	ø 5 mm	100 / 12800
3006/18	ø 6 mm	100 / 12800
3007/18	ø 7 mm	100 / 12800
3008/20	ø 8 mm	100 / 12800
3009/20	ø 9 mm	100 / 12800
3010/35	ø 10 mm	100 / 12800
3011/35	ø 11 mm	100 / 12800
3012/35	ø 12 mm	50 / 6400
3014/40	ø 14 mm	
3016/40	ø 16 mm	25 / 3200
3018/40	ø 18 mm	25 / 3200
3020/40	ø 20 mm	25 / 3200

De 2 laatste cijfers van het bestelnummer duiden de lengte van de nagel aan
Les 2 derniers chiffres du n° de commande indiquent la longueur du clou



Nagelclips - platte kabel

Attaches à clouer - câble plat

BESTELNUMMER N° DE COMMANDE	Afmetingen dimensions	Couleur	VERP. EMB.
702/0	ø 2 x 0,75 mm	Wit / Grijs	100
702/1	ø 2 x 1 mm	Wit / Grijs	100
702/2	ø 2 x 1,5 mm	Wit / Grijs	100
702/3	ø 2 x 2,5 mm	Wit / Grijs	100

Kleur : wit & grijs
Couleur : blanc & gris



Nagelclips - maten in mm

Attaches à clouer - mesures en mm

BESTELNUMMER N° DE COMMANDE	ø IN	VERP. EMB.
OL70211	3/4 mm	100 /10000
OL70212	5/6 mm	100 /10000
OL70213	7/8 mm	100 /10000
OL70214	9/10 mm	100 /10000
OL70215	11/12 mm	100 /10000
OL70216	13/14 mm	100 /5000
OL70217	15/16 mm	100 /4000
OL70218	17/18 mm	100 /3000

De 2 laatste cijfers van het bestelnummer duiden de lengte van de nagel aan. Kleur: Grijs
Les 2 derniers chiffres du n° de commande indiquent la longueur du clou. Couleur: Gris



Plugclips met nagel

Clips cheville avec clou

BESTELNUMMER N° DE COMMANDE	∅	VERP. EMB.
300620W	16 - 19 mm	200 / 3200
300720W	16 - 19 mm	100 / 1600



Betonplugclips in PVC

Clips cheville en PVC pour béton

BESTELNUMMER N° DE COMMANDE	∅	Ingang Entrées	Temp.couleur Kleur Temp.	VERP. EMB.
601620	16 - 20 mm	1	1	200 / 6000
601922	19 - 22 mm	1	1	125 / 3750
602125	21 - 25 mm	1	1	125 / 3750
611620	16 - 20 mm	2	1	125 / 3750
611922	19 - 22 mm	2	1	75 / 2250
612125	21 - 25 mm	2	1	60 / 1800

MULLER FIX



Plugclips in PVC "UP" - dubbel

Clips cheville en PVC "UP" - double

BESTELNUMMER N° DE COMMANDE	∅	Ingang Entrées	Temp.couleur Kleur Temp.	VERP. EMB.
411620	16 - 20 mm	2	1	120 / 3600

MULLER FIX



Standaard Pluggen

Cheville Standard

BESTELNUMMER N° DE COMMANDE	ø	VERP. EMB.
SEL712006	6 mm	100 / 4000
SEL712008	8 mm	100 / 2500
SEL712010	10 mm	50 / 1250
SEL712012	12 mm	25 / 625



RXO

RXO

BESTELNUMMER N° DE COMMANDE	ø	VERP. EMB.
SELRXO101	6 x 35 mm	100 / 1800
SELRXO102	8 x 50 mm	50 / 900



CGO

CGO

BESTELNUMMER N° DE COMMANDE	Afmetingen dimensions	VERP. EMB.
CGO101	ø 12 x 29 mm	25



Multimateriaal Pluggen - MQ

Cheville Multi Materiaux -MQ

BESTELNUMMER N° DE COMMANDE	Afmetingen dimensions	VERP. EMB.
MG 1050060	ø 6 x 30 mm	100 / 3600
MG 1050080	ø 8 x 40 mm	100 / 3600
MG 1050100	ø 10 x 50 mm	100 / 3600
MG 1050120	ø 12 x 60 mm	100 / 3600
MG 1380533	ø 6 x 30 mm	100 / 3600
MG 1380534	ø 8 x 40 mm	100 / 1000

Multipluggen

Cheville multi-matériaux pour tout types de vis



Multipluggen

Cheville multi-matériaux pour tout types de vis

BESTELNUMMER N° DE COMMANDE	Afmetingen dimensions	VERP. EMB.
MG 1010630	ø 6 x 35 mm	100 / 3600
MG 1010640	ø 6 x 45 mm	100 / 3600
MG 1010850	ø 8 x 50 mm	100 / 3600
MG 1011060	ø 10 x 60 mm	100 / 3600
MG 1011270	ø 12 x 70 mm	100 / 72
MG 1011470	ø 14 x 75 mm	100 / 3,6

Multipluggen

Cheville multi-matériaux pour tout types de vis

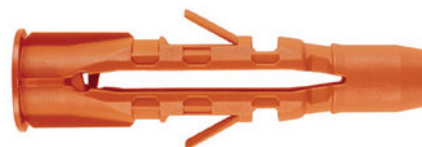

Verzinkte spreidklemmen voor gipsplaten

Chevilles à clouer d'acier zingué pour plaques de plâtre

BESTELNUMMER N° DE COMMANDE	VERP. EMB.
9401001	200 / 4800

Voor Gyproc platen 3-13 mm.
Te gebruiken met schroef 4x25 mm.
Pour plaques Gyproc de 3 à 13 mm.
A utiliser avec vis 4x25 mm.



Nylon slagplug kruis

Cheville Nylon à frapper

BESTELNUMMER N° DE COMMANDE	∅	VERP. EMB.
SELCXP102	5 X 30 mm	100 / 2000
SELCXP104	5 X 40 mm	100 / 2000
SELCXP106	6 x 40 mm	100 / 2000



Messing pluggen

Chevilles laiton

BESTELNUMMER N° DE COMMANDE	Afmetingen dimensions	Temp.couleur Kleur Temp.	VERP. EMB.
BA43-06	M6x8x22mm	1	1
BA43-08	M8x10x28mm	1	1
BA43-10	M10x12x32mm	1	1
BA43-12	M12x15x38mm	1	1



Inslagpin met draad - M6

Goujon avec filetage - M6

BESTELNUMMER N° DE COMMANDE	Afmetingen dimensions	Temp.couleur Kleur Temp.	VERP. EMB.
501018	M6 x 8 x 18	1	200 / 3200
501025	M6 x 8 x 25	1	200 / 3200
501030	M6 x 8 x 30	1	200 / 3200
501040	M6 x 8 x 40	1	100 / 2400

MULLER FIX



Inslagpin zonder draad - M4

Goujon sans filetage - M4

BESTELNUMMER N° DE COMMANDE	Afmetingen dimensions	ø	Temp.couleur Kleur Temp.	VERP. EMB.
950418	4 x 18 mm	Kraag/ Col 8 mm	1	200 / 4800
960418	4 x 18 mm	Kraag/ Col 10 mm	1	200 / 4800

MULLER FIX



Drevel

Chasse goujons

BESTELNUMMER N° DE COMMANDE	Afmetingen dimensions	VERP. EMB.
10012	M6	1

MULLER FIX



Drevel met rubber handbeschermer

Chasse goujons avec protection caoutchouc

BESTELNUMMER N° DE COMMANDE	Afmetingen dimensions	Opmerking	Temp.couleur Kleur Temp.	VERP. EMB.
90HS4	4 mm		1	1
90HSM6	M6		1	1
90HSXXX	*	Toebehoren		1

* Herstellingsset / Set de réparation

MULLER FIX



Montageband op rol - Recht

Bande de montage sur rouleau - Droit

BESTELNUMMER N° DE COMMANDE	Afmetingen dimensions	Temp.couleur Kleur Temp.	VERP. EMB.
250001	12 x 0,7mm	1	10 / 900
250002	17 x 0,7mm	1	10 / 600
250005	26 x 1,0 mm	1	10

MULLER FIX



Montageband op rol - Recht / geplastificeerd

Bande de montage sur rouleau - Droit / plastifiée

BESTELNUMMER N° DE COMMANDE	Afmetingen dimensions	Temp.couleur Kleur Temp.	VERP. EMB.
251001	14 mm	1	10/ 720
251002	19 mm	1	10/ 480

MULLER FIX



Montageband op rol - Recht geplastificeerd - Rol in karton

Bande de montage sur rouleau - Droit Plastifié - dans carto

BESTELNUMMER N° DE COMMANDE	Afmetingen dimensions	Temp.couleur Kleur Temp.	VERP. EMB.
251001C	14 mm	1	10/ 720
251002C	19 mm	1	10/ 480

MULLER FIX



Montageband op rol

Bande de montage sur rouleau

Montageband op rol - Rond

Bande de montage sur rouleau - Rond

BESTELNUMMER N° DE COMMANDE	Afmetingen dimensions	Temp.couleur Kleur Temp.	VERP. EMB.
350001	12 x 0,7mm	1	10 / 900*
350002	17 x 0,7mm	1	10 / 600*

MULLER FIX



Met Scharnier

Avec Charnière

BESTELNUMMER N° DE COMMANDE	ø	Temp.couleur Kleur Temp.	VERP. EMB.
PC0015	11-15 mm	1	100
PC0018	15-19 mm	1	100
PC0022	21-23 mm	1	100
PC0028	26-28 mm	1	100
PC0035	32-35 mm	1	100
PC0042	40-43 mm	1	50
PC0048	48-51 mm	1	50
PC0054	51-56 mm	1	50
PC0060	57-60 mm	1	50
PC0064	62-65 mm	1	50
PC1075	75-80 mm	1	25
PC0090	87-92 mm	1	25
PC0110	107-112 mm	1	25

Snelmontage met rubber
Fixation rapide avec caoutchouc



Met twee vijzen

Avec deux vis

BESTELNUMMER N° DE COMMANDE	ø	Temp.couleur Kleur Temp.	VERP. EMB.
PC1100	99-105 mm	1	25
PC1115	113-118 mm	1	25
PC1125	125-130 mm	1	25
PC1133	132-137 mm	1	25
PC1140	138-142 mm	1	25
PC1150	148-152 mm	1	25
PC1160	159-166 mm	1	25



Draadstang verzinkt

Tige filetée galvanisé

BESTELNUMMER N° DE COMMANDE	Afmetingen dimensions	Temp.couleur Kleur Temp.	VERP. EMB.
TR10006	M6x1000mm	1	1 / 100
TR10008	M8x1000mm	1	1 / 50
TR10010	M10x1000mm	1	1 / 25
TR10012	M12x1000mm	1	1 / 20
TR20006	M6x2000mm	1	1 / 50
TR20008	M8x2000mm	1	1 / 25
TR20010	M10x2000mm	1	1 / 25
TR20012	M12x2000mm	1	1 / 20
TR30006	M6x3000mm	1	1 / 50
TR30008	M8x3000mm	1	1 / 25
TR30010	M10x3000mm	1	1 / 25
TR30012	M12x3000mm	1	1 / 20

DIN 974 4.8
Inox op aanvraag
Inox sur demande



Afstandhouders

Entretoises

BESTELNUMMER N° DE COMMANDE	Afmetingen dimensions	Temp.couleur Kleur Temp.	VERP. EMB.
5720	M6-30 mm	1	1
5721	M6-50 mm	1	1
5722	M6-100 mm	1	1
5725	M8-30 mm	1	1
5726	M8-50 mm	1	1
5727	M8-100 mm	1	1

Galva



Schoefhanker sb 3x35 m8/m10 sw 13

Cheville à visser pour tige filetée sb 3x35 m8/m10 sw 13

BESTELNUMMER N° DE COMMANDE	VERP. EMB.
SYM70250	100



Keilbout

Boulon expansible

BESTELNUMMER N° DE COMMANDE	Afmetingen dimensions	RAL	VERP. EMB.
4570	M8 x32		100

kunkel**dübel**



Kabeldozen met uitbreekbare ingangen voor wartels

Boîtes de dérivation à entrées pré-imprimées

BESTELNUMMER N° DE COMMANDE	Afmetingen dimensions	ø	Ingang Entrées	VERP. EMB.
220A	80x80x50	PG 16	7	10
220AM	80x80x50	20 mm	7	10

Druksluiting / Serrage à pression
IP 54



Kabeldozen met uitbreekbare ingangen voor wartels

Boîtes de dérivation à entrées pré-imprimées presse-é

BESTELNUMMER N° DE COMMANDE	Afmetingen dimensions	ø	Ingang Entrées	VERP. EMB.
222A	100x100x55	PG 16	6	5
223A	175x110x66	PG 16	10	2
223ATA	175x110x83	PG 16	10	2
224A	220x170x120	PG 29	10	1
222AM	100x100x55	20 mm	6	5
223AM	175x110x66	20 mm	10	2
223ATAM	175x110x83	20 mm	10	2
224AM	220x170x120	25 mm	10	1

Schroefsluiting / Serrage à vis 3/4"
IP 65



BOX LINE Kabeldoos met metrische schroefingangen

BOX LINE Boîte de dérivation avec filetage métrique

BESTELNUMMER N° DE COMMANDE	Afmetingen dimensions	ø	Ingang Entrées	VERP. EMB.
J100S	102²x56 mm	M20	7	90
J100SC	102²x56 mm	M20	7	90

inclusief connector 3-fasen+n+t / inclus barrette 3-phases+n+t
IP 65



BOX LINE Kabeldozen met nippel

BOX LINE Boîtes de dérivation avec entrées étanches

BESTELNUMMER N° DE COMMANDE	Afmetingen dimensions	ø	Ingang Entrées	VERP. EMB.
J80B	83x50mm	M25	8	1
J100B	102x56mm	M25	8	1
J160B	116x70mm	M25	8	1
J200B	216x166x90mm	M32	8	1

IP 66



BOX LINE Kabeldozen gesloten

BOX LINE Boîtes de dérivation fermées

BESTELNUMMER N° DE COMMANDE	Afmetingen dimensions	ø	Ingang Entrées	VERP. EMB.
J80L	83 x 83 x 50 mm	M25	8	1
J100L	102 x 102 x 56mm	M25	8	1
J160L	166 x 116 x 70 mm	M25	8	1
J200L	216x166x90mm	M32	8	1

IP 66



Kabeldozen met nippels

Boîtes de dérivation avec entrées étanches

BESTELNUMMER N° DE COMMANDE	Afmetingen dimensions	ø	Ingang Entrées	VERP. EMB.
219B	45 x ø80 mm	PG21	4*	8
220B	80 x 80 x 50 mm	20mm	7*	10
222B	100 x 100 x 55 mm	Pg21	6**	5
223B	175 x 110 x 66 mm	Pg21	10**	2
223BTA	175 x 110 x 83 mm	Pg21	10**	2
224B	220 x 170 x 120 mm	Pg29	10**	1
226B	220 x 170 x 120 mm	Pg29	10**	1



Nippels

Embouts à gradin

BESTELNUMMER N° DE COMMANDE	Afmetingen dimensions	VERP. EMB.
MIB16	3,5-20 mm	50
MIB21	3,5-23,5 mm	50
MIB29	3,5-32 mm	50



Kabeldozen Thermoplastisch

Boîtes de dérivation Thermoplast

BESTELNUMMER N° DE COMMANDE	Afmetingen dimensions	∅	Ingang Entrées	VERP. EMB.
FE25	89x43x37	1,5-4mm	10	10/150
FE7	75x75x37	1,5-4mm	7	10/300
FE12	85x85x37	1,5-4mm	12	10/150
FE15	100x100x37	1,5-4mm	12	10/128

Schroefsluiting 3/4" / Serrage à vis 3/4"
Thermoplastisch/Thermoplastique



Glasvezel versterkte Polyester klemmenkasten

Boîtes de raccordement Polyester renforcé-fibre de verre

BESTELNUMMER N° DE COMMANDE	Afmetingen dimensions	VERP. EMB.
MGRP121209GE	120x122x90	1
MGRP122209GE	120x220x90	1
MGRP161609GE	160x160x90	1
MGRP162609GE	160x260x90	1
MGRP163609GE	160x360x90	1
MGRP165609GE	160x560x90	1
MGRP252612GE	250x255x120	1
MGRP254012GE	250x400x120	1
MGRP414012GE	405x400x120	1

OP BESTELLING
SUR COMMANDE

IP67 - RAL7000

Andere producten Eldon beschikbaar op bestelling
Autres produits Eldon sur demande

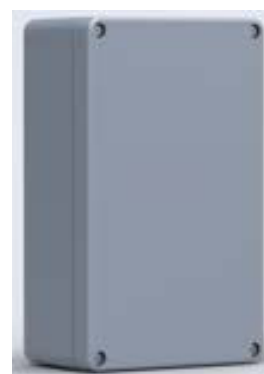

Kabeldozen serie 200

Boîtes de dérivation série 200

BESTELNUMMER N° DE COMMANDE	Afmetingen dimensions	VERP. EMB.
242-MFM2		
242MFTR	330x280x175	1

242MFTR met transparant deksel / avec couvercle transparent
IP65



Ronde kabeldoos met soepele ingang

Boîte de dérivation ronde avec membrane

BESTELNUMMER N° DE COMMANDE	Afmetingen dimensions	VERP. EMB.
M001CS	ø 65x40 mm	1
M002CS	ø 80x40 mm	1

Druksluiting / Serrage à pression
IP 65



Kabeldoos met soepele ingang

Boîte de dérivation avec membrane

BESTELNUMMER N° DE COMMANDE	Afmetingen dimensions	VERP. EMB.
M003CS	80x80x40 mm	1
M005CS	100x100x40 mm	1

Druksluiting / Serrage à pression
IP 65



Kabeldozen gesloten

Boîtes de dérivation fermées

BESTELNUMMER N° DE COMMANDE	Afmetingen dimensions
MF242	322x275x185



Kabeldozen volledig gesloten met transparant deksel

Boîtes de dérivation fermées avec couvercle transparente

BESTELNUMMER N° DE COMMANDE	Afmetingen dimensions
223LTATR	175x110x83
224LTR	220x170x120

Schroefsluiting 3/4" / Serrage à vis 3/4"



Kabeldozen PH-4A.1

Boîtes de dérivation IP65

BESTELNUMMER N° DE COMMANDE	Afmetingen dimensions	Normen Normes	VERP. EMB.
28.41	248x198x96	IP65	1
28.51	348x228x142	IP65	1
28.61	400x262x140	IP65	1



Kabeldozen met nippels PH-4A.3

Boîtes de dérivation avec entrées étanches PH-4A.3

BESTELNUMMER N° DE COMMANDE	Spécificité Specificiteit	Afmetingen dimensions	Normen Normes	VERP. EMB.
28.43		248x198x96	IP65	1
28.43-PLEXI	*4	*248x198x96		1

*Met Plexi deksel - Op aanvraag
* Avec couvercle en Plexi - sur demande



Kabeldozen met nippels PH-5A.3

Boîtes de dérivation avec entrées étanches PH-5A.3

BESTELNUMMER N° DE COMMANDE	Afmetingen dimensions	Normen Normes	VERP. EMB.
28.53	348x228x142	IP65	1



Vijs voor kabeldoos reeks 28

Vis pour boîtes de dérivation serie 28

BESTELNUMMER N° DE COMMANDE	Afmetingen dimensions	VERP. EMB.
28.998	3 cm	1
28.999	5,5 cm	1



E90 Waterdichte en brandwerende kabeldozen

E90 Boîtes étanches et anti-feu

BESTELNUMMER N° DE COMMANDE	Afmetingen dimensions	ø	Ingang Entrées	VERP. EMB.
J100BF	102x102x56	M25	7*	1
J100SF	102x102x56	M20+M25	6+1*	1
J160BF	166x116x70	M25	10	1
J200BF	216x166x90	M32	10	1

IP66



Wartel E90

Presse-étoupe E90

BESTELNUMMER N° DE COMMANDE	Afmetingen dimensions	Normen Normes	VERP. EMB.
BM20LA	20 mm	IP68	50
BM25LA	25 mm	IP68	20



Keramische connector in steatiet

Connecteur ceramique en stéatite

BESTELNUMMER N° DE COMMANDE	Afmetingen dimensions	ø	Normen Normes	VERP. EMB.
J402Z	20X18X15 mm	1,5-6mm ²	VDE	1
J1602	25x23x21 mm	1,5-10mm ²	VDE	1
J2021	33x30x23 mm	1,5-16mm ²	VDE	1

Voor stijve en flexibele draad / Pour fil rigide et flexible
VDE gekeurd - certifiés VDE



Verdeelkasten Type C / IP40 In-63A

Coffrets de distribution Type C / IP40 In-63A

BESTELNUMMER N° DE COMMANDE	Afmetingen dimensions	Modules
N4-C	232x139x99 mm	1 x 4
N8-C	215x236x112 mm	1 x 8
N12-C	287x236x112 mm	1 x 12
N18-C	396x236x112 mm	1 x 18
N24-C	287x361x112 mm	2 x 12
N36-C	287x485x112 mm	3 x 12
N2x18-C	396x361x112 mm	2 x 18
N3x18-C	396x526x112 mm	3 x 18
N48-C	287x651x112 mm	4 x 12
N4x18-C	651x396x112 mm	4 x 18



Verdeelkasten inbouw Type C / IP 40 In-63A

Coffrets de distribution à encastrer Type C / IP 40 In-63A

BESTELNUMMER N° DE COMMANDE	Afmetingen dimensions	Modules
U8-C	211x232x99 mm	1 x 8
U12-C	283x232x106 mm	1 x 12
U18-C	392x232x106 mm	1x 18
U24-C	283x357x106 mm	2 x 12
U36-C	283x482x106 mm	3 x 12
U2x18-C	392x357x106 mm	2 x 18
U3x18-C	392x522x106 mm	3 x 18
U4-C	211 x 232 x 99 mm	1 x 4

Din rail en aardingsrail inclusief en geïnstalleerd
Rail Din et barrette de terre pré-installé



Slot voor verdeelkasten

Serrure pour coffrets de distribution

BESTELNUMMER N° DE COMMANDE	Spécificité
36.81	Specifiteit Serie NEO



Verdeelkasten Type D / IP65 In-63A

Coffrets de distribution Type D / IP65 In-63A

BESTELNUMMER N° DE COMMANDE	Afmetingen dimensions	Modules
N4-D	127x200x120 mm	1 x 4
N8-D	200x200x120 mm	1 x 8
N12-D	318x258x142 mm	1 x 12
N24-D	318x383x142 mm	2 x 12
N36-D	318x507x142 mm	3 x 12
N48-D		4 X 12



Afdekplaatjes voor MCB - wit

Couvercles universels pour MCB - blanc

BESTELNUMMER N° DE COMMANDE	Afmetingen dimensions	VERP. EMB.
273MF	200x52x8 mm	10



Vijs voor verdeelkas

Vis pour coffret de distribution

Vijs voor serie C en D
Vis pour serie C et D



Slot voor verdeelkasten

Serrure pour coffrets de distribution

BESTELNUMMER N° DE COMMANDE	Spécificité
	Specificiteit
LOCKC-M	Serie C



Installatieset voor verdeelkast

Set d'installation pour coffret de distribution

BESTELNUMMER N° DE COMMANDE	VERP. EMB.
NSET-C-D	1

Installatie/vervangset voor serie C en D
Set d'installation/remplacement pour serie C et D



Verdeelkasten Type NEO / IP65 In-100A

Coffrets de distribution en saillie Type NEO / IP65 In-100A

BESTELNUMMER N° DE COMMANDE	Afmetingen dimensions	Modules
RH18S	435x260x138 mm	1 x 18
RH36/2S	435x420x138 mm	2 x 18
RH54/3S	435x580x138 mm	3 x 18
RH72/4S	435x780x138 mm	4 x 18



Slot voor verdeelkasten

Serrure pour coffrets de distribution

BESTELNUMMER N° DE COMMANDE	Spécificité
	Specificiteit
LOCKD-M	Serie D



Verdeelkasten opbouw IP 55 Incl. din rail

Coffrets de distribution en saillie IP 55

BESTELNUMMER N° DE COMMANDE	Afmetingen dimensions	Ingang Entrées	Modules
250-5AM	95x162x122 mm	6xM20+4xM25	4 + 1
250-9AM	98x162x202 mm	6xM20+4xM25	8 + 1
250-11AM	109x232x182 mm	10xM25	10 + 1
250-9B	98 X 162 X 202 mm	10 x PG21 met Nippels	8+1



Stopcontact voor borden - DIN Rail 35 mm

Prise de courant pour tableau - DIN Rail 35mm

BESTELNUMMER N° DE COMMANDE	Stroomsterkte Ampérage	Spanning tension	Temp.couleur Kleur Temp.	VERP. EMB.
C500	16A	230V	1	1/5

VDE -EN 50 0 22



Kabeldoorvoer Quickseal M32

Cable transit Quickseal M32

BESTELNUMMER N° DE COMMANDE	Afmetingen dimensions	VERP. EMB.
TPQSM32	M32	10/100



Hollewanddozen

Boîtiers pour mur creux

BESTELNUMMER N° DE COMMANDE	Afmetingen dimensions	ø	Modules	VERP. EMB.
424	45 mm	68 mm	1	10/280
426	61 mm	68 mm	1	10/240
428	45 mm	68 mm	2	5/130
429	45 mm	68 mm	3	5/90



Hollewanddoos Harde Uitvoering - Winddicht

Boîtier Rigide Pour Mur Creux - Etanche

BESTELNUMMER N° DE COMMANDE	Afmetingen dimensions	Modules	VERP. EMB.
KP64-50LD	68x70x50mm	1	110
KP64-60LD	68x70x60mm	1	84
KP64-50-2LD	142x70x50mm	2	40
KP64-50-3LD	213x70x50mm	3	30
KP64-50-4LD	284x70x50mm	4	25
KP64-50-5LD	351x70x50mm	5	14

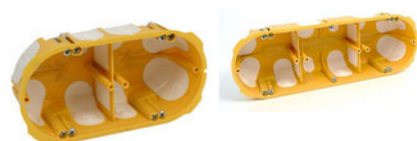

Brandwerende Hollewanddozen

Boîtiers anti-feu pour mur creux

BESTELNUMMER N° DE COMMANDE	Afmetingen dimensions	ø	VERP. EMB.
BS115	54 mm	74 mm	12/192
BS118	54 mm	2 X 74 mm	6/96

E90
Op Aanvraag / Sur Commande



HW Sound protection

HW Sound protection

BESTELNUMMER N° DE COMMANDE	Afmetingen dimensions	ø	Normen Normes
7520001	58 mm	68 mm	
7520002	58 mm	68 mm	HF

Geluidswerende Hollewanddozen
Boîtier pour mur creux insonorisé



Hollewanddoos vuurvast

Boîtier pour mur creux résistant au feu

BESTELNUMMER N° DE COMMANDE	Afmetingen dimensions	ø	VERP. EMB.
KPZ1PO	47 mm	68 mm	1

PP (halogen-free, pb-free) + foaming material
temperature resistance: -5 - +60 °C (activation of foaming material from 200 °C)
EN 1363-1:2013
EI 15 - EI 120



Universele inbouwdozen zonder Vijs

Boîtiers d'encastrement universel sans Vis

BESTELNUMMER N° DE COMMANDE	Afmetingen dimensions	Modules	Temp.couleur Kleur Temp.	VERP. EMB.
430	60x60x50mm	1	1	10/200
431	60x60x65mm	1	1	10/200

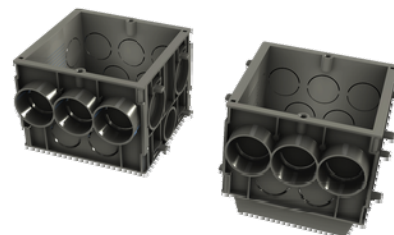

Universele inbouwdozen met Vijs

Boîtiers d'encastrement universel avec Vis

BESTELNUMMER N° DE COMMANDE	Afmetingen dimensions	Modules	Temp.couleur Kleur Temp.	VERP. EMB.
430V	60x60x50mm	1	1	10/200
431V	60x60x65mm	1	1	10/180



Inbouwdozen

Boîtiers d'encastrement

BESTELNUMMER N° DE COMMANDE	Afmetingen dimensions	Modules	VERP. EMB.
316	75x75x42mm	1	10/100
318	75x75x60mm	1	10/100



Versterkte Rechte buizen 750 N

Tubes rigides renforcé 750 N

BESTELNUMMER N° DE COMMANDE	Lengte Longueur	ø IN	VERP. EMB.
VD16	3 m	16 mm	111/5550 m
VD20	3 m	20 mm	111/5550 m
VD25	3 m	25 mm	57/5130 m
VD32	3 m	32 mm	57/4275 m
VD40	3 m	40 mm	30 m
VD50	3 m	50 mm	15 m

Light Grey = RAL 7035



Versterkte Rechte buizen 750 N

Tubes rigides renforcé 750 N

BESTELNUMMER N° DE COMMANDE	Lengte Longueur	ø IN	VERP. EMB.
VD16 R	3 m	16 mm	111/5550 m
VD20 R	3 m	20 mm	111/5550 m
VD25 R	3 m	25 mm	57/5130 m
VD32 R	3 m	32 mm	57/4275 m
VD40 R	3 m	40 mm	30 m
VD50 R	3 m	50 mm	15 m
VD63R		63 mm	15 m

R = Dark Grey = RAL 7037



Buizen HALOGEN FREE - PC

Tubes HALOGEN FREE - PC

BESTELNUMMER N° DE COMMANDE	ø	VERP. EMB.
VD16 LLH	16 mm	111/5550 m
VD20 LLH	20 mm	111/5550 m
VD20 LLHBLACK	20 mm*	111/5550 m
VD25 LLH	25 mm	57/5130 m
VD32 LLH	32 mm	57 /4275 m

Light Load (2442) : LLH
 Lengte / Longueur: 3m
 RAL 7035/ *Black RAL 9004
 PC = polycarbonaat/polycarbonate



Buizen HALOGEN FREE - PC

Tubes HALOGEN FREE - PC

BESTELNUMMER N° DE COMMANDE	ø	VERP. EMB.
VD16 MLH	16 mm	111/5550 m
VD20 MLH	20 mm	111/5550 m

Medium Load (3442) : MLH

Lengte / Longueur: 3m
RAL 7035
PC = polycarbonaat/polycarbonate
VERSTERKTE/RENFORCE 750 N



Buizen HALOGEN FREE - PC

Tubes HALOGEN FREE - PC

BESTELNUMMER N° DE COMMANDE	ø	VERP. EMB.
VD16 FLH	16 mm	111/5550 m
VD20 FLH	20 mm	111/5550 m
VD25 LH	25 mm	57/5130 m
VD32 LH	32 mm	57/4275 m
VD40 LH	40 mm	30 m
VD50 LH	50 mm	15 m
VD63 LH	63 mm	3 m

Heavy Load (4442) : FLH/LH
Lengte / Longueur: 3m
RAL 7035
PC = polycarbonaat/polycarbonate
VERSTERKTE/RENFORCE
SUPER STRONG 1250 N



HALOGEEN VRIJ RECHTE BUIS MET MOF

TUBE RIGIDE SANS HALOGÈNE AVEC MANCHON

BESTELNUMMER N° DE COMMANDE	ø	Kleur	Couleur	VERP. EMB.
VD16HFIRM- TURBO	16mm	Grijs	Gris	111 m
VD20HFIRM- TURBO	20mm	Grijs	Gris	111 m
VD25HFIRM- TURBO	25mm	Grijs	Gris	57 m
VD20HFPRM TURBO BLACK	20 mm	Zwart	Noir	111 m
univold				

Halogeen Vrij rechte buis
 PP-Blend EN 2243 > 320 N U -25°C/+105°C
 Tube rigide sans halogène
 Ral 7035
 met mof / avec manchon intégré
 PP-Blend EN 2243 > 320 N U -25°C/+105°C
 Beschikbaar in versterkte versie op bestelling
 Disponible en version renforcée sur commande



Moffen voor rechte PVC buis

Manchons pour conduite rigide en PVC

BESTELNUMMER N° DE COMMANDE	ø	RAL	VERP. EMB.
U407	16 mm	RAL 7035	100/2500
U408	20 mm	RAL 7035	100/1600
U409	25 mm	RAL 7035	25/1150
U410	32 mm	RAL 7035	25/600
U411	40 mm	RAL 7035	25
U412	50 mm	RAL 7035	5
U407 R	16 mm	RAL 7037	100/2500
U408 R	20 mm	RAL 7037	100/1600
U409 R	25 mm	RAL 7037	25/1150
U410 R	32 mm	RAL 7037	25/600
U411 R	40 mm	RAL 7037	25
U412 R	50 mm	RAL 7037	5
U413R	63 mm	RAL 7037	5

Light Grey = RAL 7035
 R = Dark Grey = RAL 7037



Bochten 90° voor rechte PVC buis

Coudes 90° pour conduite rigide en PVC

BESTELNUMMER N° DE COMMANDE	ø	RAL	VERP. EMB.
C16VD	16 mm	RAL 7035	50/2000
C20VD	20 mm	RAL 7035	50/1000
C25VD	25 mm	RAL 7035	20/500
C32VD	32 mm	RAL 7035	5
C40VD	40 mm	RAL 7035	5
C50VD	50 mm	RAL 7035	3
C16VD R	16 mm	RAL 7037	50/2000
C20VD R	20 mm	RAL 7037	50/1000
C25VD R	25 mm	RAL 7037	20/500
C32VD R	32 mm	RAL 7037	5
C40VD R	40 mm	RAL 7037	5
C50VD R	50 mm	RAL 7037	3



Light Grey = RAL 7035
R = Dark Grey = RAL 7037



Eindtullen voor rechte PVC buis

Embouts pour conduite rigide en PVC

BESTELNUMMER N° DE COMMANDE	ø	RAL	VERP. EMB.
EC16	16 mm	RAL 7035	100/7000
EC20	20 mm	RAL 7035	100/5500
EC25	25 mm	RAL 7035	50/2500
EC32	32 mm	RAL 7035	25
EC40	40 mm	RAL 7035	25
EC50	50 mm	RAL 7035	25
EC16 R	16 mm	RAL 7037	100/7000
EC20 R	20 mm	RAL 7037	100/5500
EC25 R	25 mm	RAL 7037	50/2500



Light Grey = RAL 7035
R = Dark Grey = RAL 7037



Invoertule M20

Entrées tube M20

BESTELNUMMER N° DE COMMANDE	∅	VERP. EMB.
MIBR1620	16 & 20 mm	50/2000

Light Grey = RAL 7035



Halogeenvrije flaxbuis met trekdraad

Tube flexible sans halogène avec tire-fils

BESTELNUMMER N° DE COMMANDE	∅	VERP. EMB.
ECICTA20HFT	20 mm	100 m
ECICTA25HFT	25 mm	50 m
ECICTA20HF	20 mm*	100 m
ECICTA25HF	25 mm*	50 m



Buis halfzacht, met trekdraad

Tube semi rigide, avec tire-fil

BESTELNUMMER N° DE COMMANDE	∅	VERP. EMB.
ERFE20G	20 mm	100 m
ERFE25G	25 mm	50 m
univoltd		



Rechte buis

Tube rigide

BESTELNUMMER N° DE COMMANDE	∅	VERP. EMB.
VD20 Black	20 mm	111m
VD20 White	20 mm	111m
VD20 LLHBLACK	20 mm*	111/5550 m

Lengte / Longueur: 3m

*LSOH

White = RAL 9003

Black = RAL 9004



Eindstuk

Embout

BESTELNUMMER N° DE COMMANDE	Afmetingen dimensions	VERP. EMB.
EC20 Black	20 mm	100 / 5500
EC20 White	20 mm	100 / 5500

Black = RAL 9004

White = RAL 9003



PVC Stop

Bouchon PVC

BESTELNUMMER N° DE COMMANDE	Afmetingen dimensions	VERP. EMB.
907M20 Black	20 mm	50 / 2000

Black = RAL 9004



Buisinvoer

Entrée tube

BESTELNUMMER N° DE COMMANDE	Afmetingen dimensions	VERP. EMB.
MIBR1620 Black	16/20 mm	50 / 2000
MIBR1620 White	16/20 mm	50 / 2000

White = RAL 9003
Black = RAL 9004



Mof

Manchon

BESTELNUMMER N° DE COMMANDE	Afmetingen dimensions	VERP. EMB.
U408 White	20 mm	50 / 1600
U408 Black	20 mm	100 / 1600
U409 Black	25 mm	25 / 1125

White = RAL 9003
Black = RAL 9004



Veerklem Black & White

Attache ressort Black & White

BESTELNUMMER N° DE COMMANDE	Afmetingen dimensions	VERP. EMB.
204 White	20 mm	100 / 3000
204 Black	20 mm	100 / 3000
208 Black	25 mm	50 / 1500

White = RAL 9003

Black = RAL 9004



Aaneenschuifbare drukklemmen

Attaches à pression à juxtaposer

BESTELNUMMER N° DE COMMANDE	Afmetingen dimensions	VERP. EMB.
2036 Black	12 - 20 mm	50 / 1500
2037 Black	16 - 26 mm	50 / 1500

Black = RAL 9004



Nagelclips - maten in mm

Attaches à clouer - mesures en mm

BESTELNUMMER N° DE COMMANDE	ø	VERP. EMB.
3007-18Black	7 mm*	100 / 12800

De 2 laatste cijfers van het bestelnummer duiden de lengte van de nagel aan. Kleur: Grijs

Les 2 derniers chiffres du n° de commande indiquent la longueur du clou. Couleur: Gris

*Zwart / Noire



Wartel

Presse-étoupe

BESTELNUMMER N° DE COMMANDE	Afmetingen dimensions	VERP. EMB.
BM20 White	20 mm	50 / 2000
BM20 Black	20 mm	50 / 2000

White = RAL 9003
Black = RAL 9004



Boxline kabeldoos schroefingangen M20

Boxline boîte de dérivation filetage M20

BESTELNUMMER N° DE COMMANDE	Afmetingen dimensions	ø	Ingang Entrées	VERP. EMB.
J100S Black	102²x56 mm	M20	7	1 / 90
J100S White	102²x56 mm	M20	7	1 / 90

White = RAL 9003
Black = RAL 9004



Kabeldoos thermoplast

Boîte de dérivation thermoplastique

BESTELNUMMER N° DE COMMANDE	Afmetingen dimensions	Ingang Entrées	VERP. EMB.
FE25 Black	89 x 43 x 37 mm	10	10 / 150
FE25 White	89 x 43 x 37 mm	10	10 / 150
FE7 Black	75x75x37	7	10/300

Black = RAL 9004
White = RAL 9010
ø 1,5-4mm



Metalen buizen, zonder schroefdraad - Galvanisch verzinkt

Tubes en métal, sans filetage - Galvanisé

BESTELNUMMER N° DE COMMANDE	Afmetingen dimensions	VERP. EMB.
010TARM016	M16 x 1,5	3 m/51 m
010TARM020	M20 x 1,5	3 m/30 m
010TARM025	M25 x 1,5	3 m/30 m
010TARM032	M32 x 1,5	3 m/21 m
010TARM040	M40 x 1,5	3 m/15 m
010TARM050	M50 x 1,5	3 m/15 m
010TARM063	M63 x 1,5	3 m/9 m

Conform EN 61386 21 - code 5557
OP BESTELLING / SUR COMMANDE : INOX



Buis Zonder Schroefdraad - Rvs Aisi 304

Tubes INOX sans filetage

BESTELNUMMER N° DE COMMANDE	Afmetingen dimensions	VERP. EMB.
060TARMi20	M20	3 m - 30 m
060TARMi25	M25	3 m - 30 m
060TARMi32	M32	3 m - 21 m
060TARMi40	M40	3 m - 15 m
060TARMi50	M50	3 m - 15 m

Op aanvraag / Sur demande



Metalen bochten, zonder schroefdraad - Galvanisch verzinkt

Coudes en métal 90°, sans filetage - Galvanisé

BESTELNUMMER N° DE COMMANDE	ø	VERP. EMB.
020CARM016	M16	10
020CARM020	M20	10
020CARM025	M25	10
020CARM032	M32	10
020CARM040	M40	5
020CARM050	M50	5
020CARM063	M63	5

Conform EN 61386 21 - code 5557
OP BESTELLING / SUR COMMANDE : INOX



Metalen bochten, zonder schroefdraad - Rvs Aisi 304

Coudes en métal 90°, sans filetage - INOX

BESTELNUMMER N° DE COMMANDE	Afmetingen dimensions	VERP. EMB.
061CARM120	M20	5
061CARM125	M25	5
061CARM132	M32	5
061CARM140	M40	5
061CARM150	M50	1

Op aanvraag / Sur demande



Koppelstukken, zonder schroefdraad - Galvanisch verzinkt

Manchons sans filetage - Galvanisé

BESTELNUMMER N° DE COMMANDE	ø	VERP. EMB.
020MARM016	M16 - L45 mm	100
020MARM020	M20 - L50 mm	100
020MARM025	M25 - L55 mm	60
020MARM032	M32 - L65 mm	30
020MARM040	M40 - L70 mm	25
020MARM050	M50 - L90 mm	12
020MARM063	M63 - L105 mm	6

Conform EN 61386 21 - code 5557
OP BESTELLING / SUR COMMANDE : INOX



Koppelstukken, zonder schroefdraad - Rvs Aisi 304

Manchons sans filetage - INOX

BESTELNUMMER N° DE COMMANDE	Afmetingen dimensions	VERP. EMB.
061MACMI20	M20	12
061MARM125	M25	8
061MACMI32	M32	5
061MACMI40	M40	3
061MACMI50	M50	2

Conform EN 61386 21 - code 5557
Op aanvraag / Sur demande



Brandwerend Schroefanker - MMS Plus

Vis à maintient de fonction - MMS Plus

BESTELNUMMER N° DE COMMANDE	Spécificité Specificiteit	Afmetingen dimensions	VERP. EMB.
9421	1	MMS-PLUS MS 7.5X40	50
9422	2	MMS-PLUS ST 6.0X55	50
9423	3	MMS-PLUS P 6.0X50	50
9424	4	MMS-PLUS P 6.0X35	50



kunkeldübel



Pgb Carrosserie rondellen - Verzinkt

Rondel carrosserie - Zingué

BESTELNUMMER N° DE COMMANDE	Afmetingen dimensions	VERP. EMB.
PGB0525015 - CAROS,05025Z	M5 - 5,3 x 25 x 1,5	200
PGB0618016 - CAROS,06018Z	M6 - 6,4 x 18 x 1,6	200
PGB0625015 - CAROS,06025Z	M6 - 6,4 x 25 x 1,5	200
PGB0824020 - CAROS,08024Z	M8 - 8,4 x 24 x 2,0	200
PGB0830015 - CAROS,08030Z	M8 - 8,5 x 30 x 1,5	200
PGB1030025 - CAROS,10030Z	M10 - 10,5 x 30 x 2,5	200



Pgb Zeskantmoeren - Verzinkt

Pgb Ecrous hexagonaux - Zingué

BESTELNUMMER N° DE COMMANDE	Afmetingen dimensions	VERP. EMB.
PGB934-806 00934,06 Z	M6	200
PGB934-808 00934,08 Z	M8	200
PGB934-810 00934,10 Z	M10	200



Pgb Universele spaanplaat Schroef verzinkt

Pgb Vis Universelle Zinguée

BESTELNUMMER N° DE COMMANDE	Afmetingen dimensions	VERP. EMB.
PGBZ40020V MWVZVK40020 Z	4,0 X 20	200
PGBZ40025V MWVZVK40025 Z	4,0 X 25	200
PGBZ40030V MWVZVK40030 Z	4,0 X 30	200
PGBZ40035V MWVZVK40035 Z	4,0 X 35	200
PGBZ40040V MWVZVK40040 Z	4,0 X 40	200
PGBZ40045V MWVZVK40045 Z	4,0 X 45	200
PGBZ45040V MWVZVK45040 Z	4,5 X 40	200
PGBZ45045V MWVZVK45045 Z	4,5 X 45	200
PGBZ45050V MWVZVK 45050 Z	4,5 X 50	200
PGBZ45060V MWVZVK 45050 Z	4,5 X 60	200
PGBZ45080V MWVZVK 45080 Z	4,5 X 80	200
PGBZ50050VMWVZVK50050 Z	5,0 X 50	200
PGBZ50090V MWVZVK50050 Z	5,0 X 90	200
PGBZ60040V MWVZVK60040 Z	6,0 X 40	200
PGBZ60090V MWVZVK60090 Z	6,0 X 60	200
PGBZ60090V MWVZVK60060 Z	6,0 X 60	200

VK-POZ-VD



Pgb Stokeinden verzinkt

Pgb Goujons à deux filets

BESTELNUMMER N° DE COMMANDE	Afmetingen dimensions	VERP. EMB.
HB0050	M8-50 mm	100
HB0060	M8-60 mm	100
HB0070	M8-70 mm	100
HB0080	M8-80 mm	100
HB0100	M8-100 mm	100
HB0120	M8-120 mm	100



Pgb Stokeinden verzinkt

Pgb Goujons à deux filets

BESTELNUMMER N° DE COMMANDE	Afmetingen dimensions	VERP. EMB.
HB0150	M8-150 mm	100
HB0180	M8-180 mm	100



Wartels PVC - Metrische reeks

Presse-étoupes PVC - Série Métrique

BESTELNUMMER N° DE COMMANDE	Afmetingen dimensions	VERP. EMB.
905M12	ø 12	50
905M16	ø 16	50
905M20	ø 20	50 / 2250
905M25	ø 25	50

Polystyrol
IP 65
- 5°C à + 60°C



Wartels PVC met trekontlasting - Metrische reeks

Presse-étoupes PVC à serrage - Série Métrique

BESTELNUMMER N° DE COMMANDE	ø	VERP. EMB.
BM12	12 mm	50 / 2000
BM16	16 mm	50 / 2000
BM20	20 mm	50 / 2000
BM25	25 mm	20 / 800
BM32	32 mm	20 / 600
BM40	40 mm	10 / 300
BM50	50 mm	5 / 200
BM63	63 mm	5 / 120

Met skintop en trekontlasting
Avec skintop et serrage étendu
Polyamide
IP 68 - 20°C à + 125°C



Tegenmoeren PVC - Metrische reeks

Contre-écrous PVC - Série Métrique

BESTELNUMMER N° DE COMMANDE	ø	VERP. EMB.
PM12	12 mm	50/4800
PM16	16 mm	50/4800
PM20	20 mm	50/4800
PM25	25 mm	20/1920
PM32	32 mm	20/1920
PM40	40 mm	10/960
PM50	50 MM	10/480
PM63	63 MM	5/480



Wartels PVC met trekcontlasting - Metrische reeks

Presse-étoupes PVC à serrage - Série Métrique

BESTELNUMMER N° DE COMMANDE	Afmetingen dimensions	Opmerking	Nbr. LED Aantal LED
OMRL05-A7	ø M20 x 1.5	Multihole IP 68	Multihole IP 68

Multihole
IP 68



Brandwerende zelfdovende wartel

Presse-étoupes anti feu

BESTELNUMMER N° DE COMMANDE	Afmetingen dimensions	Normen Normes	VERP. EMB.
BM20LA	20 mm	IP68	50

IP 68



Stoppen PVC - Metrische reeks

Bouchons PVC - Série Métrique

BESTELNUMMER N° DE COMMANDE	ø	VERP. EMB.
907M12	12 mm	100
907M16	16 mm	100
907M20	20 mm	100
907M25	25 mm	25
907M32	32 mm	20
907M40	40 mm	10
907M50	50 mm	4
907M63	63 mm	4



Wurgnippels PVC - Metrische reeks

Raccords à visser PVC - Série Métrique

BESTELNUMMER N° DE COMMANDE	∅	VERP. EMB.
908M16	16 mm	100
908M20	20 mm	100
908M25	25 mm	100
908M32	32 mm	50
908M40	40 mm	25
908M50	50 mm	10



ORTAC



Drukmoeren PVC - Metrische reeks

Boulons de pression PVC - Série Métrique

BESTELNUMMER N° DE COMMANDE	∅	VERP. EMB.
909M16	16 mm	100
909M20	20 mm	100



Vergrotingen PVC - Metrische reeks

Augmentations PVC - Série Métrique

BESTELNUMMER N° DE COMMANDE	∅	∅ IN	Temp.couleur Kleur Temp.	VERP. EMB.
ME1216	M12	M16	1	100
ME1620	M16	M20	1	100
ME2025	M20	M25	1	100
ME2532	M25	M32	1	50
ME3240	M32	M40	1	50



Verkleiningen PVC - Metrische reeks

Réductions PVC - Série Métrique

BESTELNUMMER N° DE COMMANDE	ø	ø IN	Temp.couleur Kleur Temp.	VERP. EMB.
MR1612	M16	M12	1	100
MR2012	M20	M12	1	100
MR2016	M20	M16	1	100
MR2512	M25	M12	1	100
MR2516	M25	M16	1	100
MR2520	M25	M20	1	100
MR3212	M32	M12	1	50
MR3216	M32	M16	1	50
MR3220	M32	M20	1	50
MR3225	M32	M25	1	50
MR4016	M40	M16	1	50
MR4020	M40	M20	1	50
MR4025	M40	M25	1	50
MR4032	M40	M32	1	50
MR5020	M50	M20	1	25
MR5025	M50	M25	1	25
MR5032	M50	M32	1	25
MR5040	M50	M40	1	25
MR6325	M63	M25	1	25
MR6332	M63	M32	1	25
MR6340	M63	M40	1	25
MR6350	M63	M50	1	25



Wartels PVC - Pg reeks

Presse-étoupes PVC - Série Pg

BESTELNUMMER N° DE COMMANDE	ø	VERP. EMB.
90507	PG7	50
90509	PG9	50 / 3750
90511	PG11	50 / 2700
90513	PG13,5	50 / 2700
90516	PG16	50 / 1850
90521	PG21	20 / 1080
90529	PG29	20 / 440
90536	PG36	10 / 220
90548	PG48	5



Polystyrol
Schokbestendig / Résistant au choc
Wurgring in rubber / Bague d'échanchéité en caoutchouc
Drukrondeel in gegalvaniseerd ijzer / Rondelle de pression en acier galvanisé
IP65 -5°C à +60°C
DIN 46320 - A



Wartels PVC met trekcontlasting - Pg reeks

Presse-étoupes PVC à serrage - Série Pg

BESTELNUMMER N° DE COMMANDE	Afmetingen dimensions	Nbr. LED Aantal LED	VERP. EMB.
9707	ø Pg7	Résistant à l'huile Rondelle en neoprène	100
9709	ø Pg9	Résistant à l'huile Rondelle en neoprène	100
9711	ø Pg11	Résistant à l'huile Rondelle en neoprène	100
9713	ø Pg13,5	Résistant à l'huile Rondelle en neoprène	100
9716	ø Pg16	Résistant à l'huile Rondelle en neoprène	50
9721	ø Pg21	Résistant à l'huile Rondelle en neoprène	50
9729	ø Pg29	Résistant à l'huile Rondelle en neoprène	25
9736	ø Pg36	Résistant à l'huile Rondelle en neoprène	10
9748	ø Pg48	Résistant à l'huile Rondelle en neoprène	5



Polyamide
Oliebestendig / Résistant à l'huile
Dichtring in neopreen / Rondelle en neoprène IP 68 / 5 bar
- 20°C à + 80°C



Tegenmoeren PVC - Pg reeks

Contre-écrous PVC - Série Pg

BESTELNUMMER N° DE COMMANDE	ø	VERP. EMB.
90607	PG7	50
90609	PG9	50
90611	PG11	50
90613	PG13,5	50 / 5600
90616	PG16	50 / 5600
90621	PG21	20 / 2240
90629	PG29	20 / 2240
90636	PG36	10
90648	PG48	10



Polystyrol
Schokbestendig / Résistant au choc
- 5°C à + 60°C
DIN 46320 - L



Stoppen PVC - Pg reeks

Bouchons PVC - Série Pg

BESTELNUMMER N° DE COMMANDE	ø	VERP. EMB.
90707	PG7	100
90709	PG9	100
90711	PG11	100
90713	PG13,5	50
90716	PG16	50
90721	PG21	50
90729	PG29	50
90736	PG36	50
90748	PG48	25



Polystyrol
Schokbestendig / Résistant au choc
- 5°C à + 60°C
DIN 46320 - N



Wartels Metrisch Messing Presse-étoupes Laiton nickelé Métrique

Wartels Messing met trektoelasting - Metrische reeks

Presse-étoupes Laiton nickelé à serrage - Série Métrique

BESTELNUMMER N° DE COMMANDE	ø	VERP. EMB.
50612M	12 mm	20 / 100
50616M	16 mm	20 / 100
50620M	20 mm	20 / 100
50625M	25 mm	20 / 100
50632M	32 mm	10 / 100
50640M	40 mm	10 / 100
50650M	50 mm	5 / 50
50663M	63 mm	1 / 10

Messing / Laiton nickelé
IP68



Tegenmoeren

Contre-écrous

BESTELNUMMER N° DE COMMANDE	ø	VERP. EMB.
HU202212	12 mm	20 / 100
HU202216	16 mm	20 / 100
HU202220	20 mm	20 / 100
HU202225	25 mm	20 / 100
HU202232	32 mm	10 / 100
HU202240	40 mm	10 / 100
HU202250	50 mm	5 / 50
HU202263	63 mm	1 / 10

Messing / Laiton nickelé



Veerklemmen

Attaches ressort

BESTELNUMMER N° DE COMMANDE	∅	VERP. EMB.
108	50 mm	25 / 600

M6 Polyamide
Kleur : grijs / Couleur : gris



Aaneenschuifbare veerklemmen

Attaches ressort à juxtaposer

BESTELNUMMER N° DE COMMANDE	∅	VERP. EMB.
211	16 mm	100 / 4000
204	20 mm	100 / 3000
208	25 mm	50 / 1500
209	32 mm	50 / 1500
210	40 mm	25 / 750

M6 Polyamide
Kleur : grijs / Couleur : gris



Aaneenschuifbare drukklemmen

Attaches à pression à juxtaposer

BESTELNUMMER N° DE COMMANDE	∅	VERP. EMB.
2035	6 - 13 mm	50 / 3750
2036	12 - 20 mm	50 / 1500
2037	16 - 26 mm	50 / 1500
2038	18 - 30 mm	50 / 1200
2039	27 - 43 mm	25 / 750

M6 Polyamide
Kleur : grijs / Couleur : gris



Plug voor klem

Cheville pour attaches

BESTELNUMMER N° DE COMMANDE	VERP. EMB.
20436	100

M6 Polyamide
Plug voor klem / Cheville pour attaches



Universele klemmen

Attaches universelles

BESTELNUMMER N° DE COMMANDE	ø	VERP. EMB.
031G	16 - 22 mm	50 / 2700
031T	16 - 22 mm	50 / 2700

M6 Polyamide
Kleur : grijs / Couleur : gris



Aaneenschuifbare veerklemmen met M6 plug

Attaches ressort à juxtaposer avec cheville M6

BESTELNUMMER N° DE COMMANDE	∅	VERP. EMB.
211 D	16 mm	100/4000
204 D	20 mm	50/2000

M6 Polyamide
Kleur : grijs / Couleur : gris

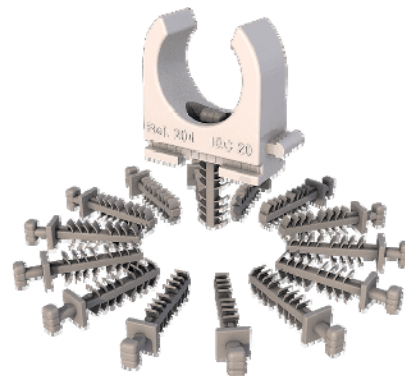

Aaneenschuifbare drukklemmen met M6 plug

Attaches à pression à juxtaposer avec cheville M6

BESTELNUMMER N° DE COMMANDE	∅	VERP. EMB.
2036 D	12 - 20 mm	50 / 1500
2037 D	16 - 24 mm	50 / 1200

M6 Polyamide
Kleur : grijs / Couleur : gris



Universele klemmen

Attaches universelles

BESTELNUMMER N° DE COMMANDE	∅	VERP. EMB.
031G	16 - 22 mm	50 / 2700
031T	16 - 22 mm	50 / 2700

M6 Polyamide
Kleur : grijs / Couleur : gris



Vorkklemmen

Attaches fourchette

BESTELNUMMER N° DE COMMANDE	ø	VERP. EMB.
512	10 mm	100/1000
513	12 mm	100/1000
515	14 - 15 mm	100/1000
516	16 - 18 mm	50/2500
517	20 - 22 mm	50/2500
518	22 - 25 mm	50/2700
519	35 mm	30/1080
520	42 mm	20/720

M6 Polyamide
Kleur : grijs / Couleur : gris



Vorkklemmen - dubbel

Attaches fourchette - double

BESTELNUMMER N° DE COMMANDE	Afmetingen dimensions	Nbr. LED Aantal LED	VERP. EMB.
512/2	ø 10 mm	Pour fixation simultane de 2 câbles ou tubes.	50
513/2	ø 12 mm	Pour fixation simultane de 2 câbles ou tubes.	50
515/2	ø 14 - 15 mm	Pour fixation simultane de 2 câbles ou tubes.	50
516/2	ø 16 - 18 mm	Pour fixation simultane de 2 câbles ou tubes.	25 / 1350
517/2	ø 20 - 22 mm	Pour fixation simultane de 2 câbles ou tubes.	25 / 1350
518/2	ø 22 - 25 mm	Pour fixation simultane de 2 câbles ou tubes.	25

Voor gelijktijdige bevestiging van 2 kabels of buizen.
Pour fixation simultane de 2 câbles ou tubes.

M6 Polyamide
Kleur : grijs / Couleur : gris



KZM kabelzadels

KZM attaches

BESTELNUMMER N° DE COMMANDE	∅	VERP. EMB.
905	5 - 14 mm	100/4000
906	6 - 17 mm	50/2000
907	15 - 25 mm	50/1200
908	24 - 34 mm	25/750

Polypropyleen / Polypropylène
Vijs in polystyrol / Vis en polystyrol



KZM kabelzadels - dubbel

KZM attaches - double

BESTELNUMMER N° DE COMMANDE	Afmetingen dimensions	VERP. EMB.
906/2	∅ 6 - 17 mm	50 / 1500

Polypropyleen / Polypropylène
Vijs in polystyrol / Vis en polystyrol



Slagklemmen

Attaches intercalaires

BESTELNUMMER N° DE COMMANDE	∅	VERP. EMB.
2047	5 - 25 mm	100 / 5400
2048	8 - 38 mm	100 / 3000

Snelle montage voor rail 761 & 2761
Fixation rapide pour rail 761 & 2761



Railklemmen

Attaches avec vis pour rail

BESTELNUMMER N° DE COMMANDE	∅	VERP. EMB.
2050	7 - 25 mm	100 / 5400
2051	13 - 38 mm	100 / 3000

Voor rail 761 & 2761
Pour rail 761 & 2761



Aaneenschuifbare 'Clic' klemmen

Attaches 'Clic' à juxtaposer

BESTELNUMMER N° DE COMMANDE	∅	Temp.couleur Kleur Temp.	VERP. EMB.
701516	15 - 16 mm	1	50/1350
701920	20 - 22 mm	1	50/900
702225	25 - 28 mm	1	50/400
703235	32 - 35 mm	1	50/800

MULLER FIX



Klembeugels "Marine"

Attaches "Marine"

BESTELNUMMER N° DE COMMANDE	Afmetingen dimensions	VERP. EMB.
97000/12	∅ 12 mm	300 / 1200
97000/16	∅ 16 mm	250 / 1000
97000/20	∅ 20 mm	200 / 800
97000/25	∅ 25 mm	150 / 600
97000/28	∅ 28 mm	125 / 500

Afmetingen / Dimensions : 20 x 1,25 mm
Gat / Trou : 5 mm



Klembeugels "Speed"

Attaches "Speed"

BESTELNUMMER N° DE COMMANDE	ø	VERP. EMB.
9701016	16 mm	250 / 1000
9701020	20 mm	175 / 700
9701025	25 mm	150 / 600
9700316	2 x 16 mm	100 / 400
9700320	2 x 20 mm	75 / 300
9700325	2 x 25 mm	50 / 200

Schietbeugel
Attache pour tirer



IJzeren inslagbeugels

Attaches à frapper en métal

BESTELNUMMER N° DE COMMANDE	Afmetingen dimensions	VERP. EMB.
91009/00	ø 16 - 20 mm	500 / 2000



IJzeren zadels - rood gelakt

Attaches en acier - rouge laquée

BESTELNUMMER N° DE COMMANDE	Afmetingen dimensions	VERP. EMB.
91000/01	ø 16 mm	500 / 2000
91000/02	ø 20 mm	350 / 1400
91000/04	ø 25 mm	150 / 600
91000/05	ø 32 mm	100 / 400
91000/26	ø 40 mm	75 / 300
91000/07	ø 50 mm	50 / 200
91000/29	ø 2 x 16 mm	250 / 1000
91000/30	ø 3 x 16 mm	200 / 800
91000/31	ø 4 x 16 mm	150 / 600
91000/66	ø 2 x 20 mm	200 / 800
91000/67	ø 3 x 20 mm	150 / 600



IJzeren zadels - verzinkt

Attaches en acier - galvanisé

BESTELNUMMER N° DE COMMANDE	Afmetingen dimensions	VERP. EMB.
91001/16	ø 16 mm	500 / 2000
91001/20	ø 20 mm	350 / 1400
91001/26	ø 25 mm	150 / 600
91001/32	ø 32 mm	100 / 400
91001/40	ø 40 mm	75 / 300
91001/50	ø 50 mm	50 / 200
91000/37	ø 2 x 16 mm	250 / 1000
91000/38	ø 3 x 16 mm	200 / 800
91007/07	ø 4 x 16 mm	150 / 600
91000/46	ø 2 x 20 mm	200 / 800
91000/47	ø 3 x 20 mm	150 / 600



Zadels enkel pad - gegalvaniseerd

Attaches simple patte - galvanisé

BESTELNUMMER N° DE COMMANDE	Afmetingen dimensions	VERP. EMB.
97009/16	ø 16 mm	500 / 2000
97009/20	ø 20 mm	350 / 1400
97009/25	ø 25 mm	150 / 600



Zadels in U-vorm - rood gelakt

Attaches en forme U - rouge laquée

BESTELNUMMER N° DE COMMANDE	Afmetingen dimensions	VERP. EMB.
91000/56	ø 16 mm	500 / 2000
91000/57	ø 20 mm	350 / 1400
91009/03	ø 25 mm	150 / 600



Aaneenschuifbare klem SUPER T

Attache à juxtaposer SUPER T

BESTELNUMMER N° DE COMMANDE	ø	VERP. EMB.
ST16	16 mm	100/3000
ST20	20 mm	100/3000
ST25	25 mm	100/3000
ST32	32 mm	100/3000
ST40	40 mm	50/1500

M6 Polyamide
Kleur : grijs
Couleur : gris



Deksel voor Super T

Couvercle pour Super T

BESTELNUMMER N° DE COMMANDE	Afmetingen dimensions	VERP. EMB.
STC16	16 mm	100/9600
STC20	20 mm	100/9600
STC25	25 mm	100/9600
STC32	32 mm	100/9600
STC40	40 mm	50/4800

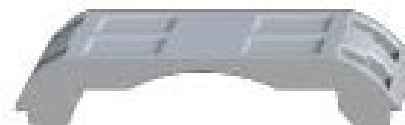

Plug M6 voor veer- en drukklemmen

Cheville M6 pour attaches ressort et à pression

BESTELNUMMER N° DE COMMANDE	Afmetingen dimensions	VERP. EMB.
PSTB-4	27 mm	100/9600
PSTB-7	42 mm	100/9600

M6 Polyamide
Kleur : grijs
Couleur : gris
10 posities / 10 positionS

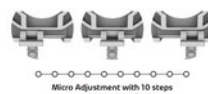

Micro Adjustment with 10 steps
10 mm total amplitude



Funcatiebehoud Kabeldrager in metaal

Attache pour câble en métal à maintien de fonction

BESTELNUMMER N° DE COMMANDE	∅	VERP. EMB.
28481	60	50
28483	88	25

Funcatiebehoud E30 en E60. Conform DIN4102-12
Tenue de fonction anti feu E30 et E60. DIN4102-12

kunkeldübel



Verzamelbeugel Cable guide Funcatiebehoudbevestiging

Collier pour câbles à maintien de fonction

BESTELNUMMER N° DE COMMANDE	Afmetingen dimensions	VERP. EMB.
9702845	74x73 mm	1/36

E30-E90



Klem voor buis en kabel met eenzijdige schuifbare sluiting

Collier pour câble et tube-fermeture unilatérale coulissant

BESTELNUMMER N° DE COMMANDE	∅	Temp.couleur Kleur Temp.	VERP. EMB.
5605-16	14-18 mm	1	100/1300
5605-22	19-23 mm	1	75/1200
5605-28	24-28 mm	1	50/1000
5605-38	30-38 mm	1	40/640
5605-50	39-52 mm	1	30/360
5605-60	53-61 mm	1	20/200

E60 (volgens/selon DIN 4102-12)
OP BESTELLING / SUR COMMANDE : INOX



FBB beugel, inclusief schroefanker - E90

Attache, cheville à visser incluse - E90

BESTELNUMMER N° DE COMMANDE	∅	VERP. EMB.
9700806	6 mm	200 / 800
9700808	8 mm	200 / 800
9700810	10 mm	200 / 800
9700812	12 mm	200 / 800
9700814	14 mm	150 / 600
9700816	16 mm	150 / 600
9700819	19 mm	150 / 600
9700825	25 mm	100 / 400
9702816	16 mm	75/300
9702819	19 mm	75/300
9700850	*1	
9700855	*2	
9700860	*3	
9230460	*4	



Per verpakking een SDS boor (torx bitje) inclusief

*1 Schroefanker - TSM

*2 Schroefbit - Torx 25 - 1/4"

*3 SDS functiebehoudboor - dia. 5x110

*4 Duimnagel E30 - E90 - E120

Une mèche SDS (torx) incluse par emballage

*1 Vis maintien de fonction - TSM

*2 nr 25 Embout de vissage - Torx 25 - 1/4"

*3 Mèche SDS - dia. 5x110

*4 Cheville à Pousser E30 - E90 - E120



Functiebehoudbevestiging Met hout Schroef

Attache avec vis à bois incluse - E90

BESTELNUMMER N° DE COMMANDE	Afmetingen dimensions	VERP. EMB.
9700852	TSM 5 x 60 LK	75



FBB beugel, inclusief inslaganker - E90

Attache, cheville à frapper incluse - E90

BESTELNUMMER N° DE COMMANDE	∅	VERP. EMB.
9700826	6 mm	200 / 800
9700828	8 mm	200 / 800
9700830	10 mm	200 / 800
9700832	12 mm	200 / 800
9700834	14 mm	150 / 600
9700836	16 mm	150 / 600
9700839	19 mm	150 / 600
9700845	25 mm	100 / 400
9702836	16 mm	75/300
9702839	19 mm	75/300
9700880	*2	
9700875	*1	

*1 SDS functiebehoudboor - dia. 6x110

*2 Inslaganker TDN 6/35

*1 Mèche SDS - dia. 6x110

*2 Cheville à frapper maintien de fonction TDN 6/35



FBB Beugel en Duim Nagel

Attache + cheville a Pousser maintien de fonction

BESTELNUMMER N° DE COMMANDE	Omschr.	Descr.	∅	VERP. EMB.
9700817	Enkel	Simple	16 mm	150/ 600
9700820	Enkel	Simple	19 mm	150/ 600
9702817	Dubbel	Double	16 mm	150/ 600
9702820	Dubbel	Double	19 mm	150/ 600



Spiralen

Spirales

BESTELNUMMER N° DE COMMANDE	ø	VERP. EMB.
CP03	3 mm	50 m
CP06	6 mm	25 m
CP08	8 mm	25 m
CP10	10 mm	25 m
CP12	12 mm	25 m
CP20	20 mm	10 m
CPN03	3 mm	50 m
CPN06	6 mm	25 m
CPN08	8 mm	25 m
CPN10	10 mm	25 m
CPN12	12 mm	25 m
CPN20	20 mm	10 m



CP.. = transparant
CNP.. = zwart / noir

CANALFAST

Polyester beschermkous

Gaine de protection polyestère

BESTELNUMMER N° DE COMMANDE	ø	VERP. EMB.
Guest05	5-10 mm	200 m
Guest10	10-18 mm	200 m
Guest20	20-30 mm	100 m
Guest30	30-45 mm	100 m
Guest50	50-75 mm	50 m



CANALFAST

Mini Bedradings Kanaal

Canaux De Cablage Mini

BESTELNUMMER N° DE COMMANDE	Afmetingen dimensions	VERP. EMB.
FLX10	13 x 15 mm	25 m
FLX20	20 x 24 mm	25 m
FLX30	29 x 33 mm	25 m
FLX40	40 x 44 mm	25 m

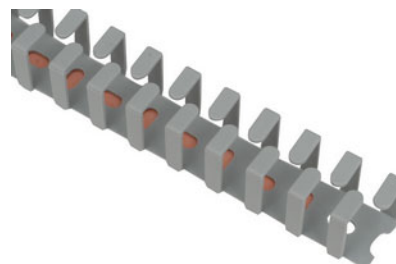

Lengte / longueur : 500 mm

CANALFAST

Aardstaven kruisvorm met vlag

Piquets de terre en forme de croix avec vente

BESTELNUMMER N° DE COMMANDE	Afmetingen dimensions	VERP. EMB.
AM L511	1000 mm	5
AM L512	1500 mm	5
AM L513	2000 mm	5
AM L514	2500 mm	5
AM L515	3000 mm	5
AML512-E	1500 mm*	5

*SANS DRAPEAU
50 x 50 x 3 mm
Warm verzinkt / Galvanisé chaud
*ZONDER VLAG

MULLER FIX



Klemschroeven voor aardstaaf

Boulons de serrage pour piquet de terre

BESTELNUMMER N° DE COMMANDE	Afmetingen dimensions	VERP. EMB.
AM M1	mm	10
AM M2	mm	10

Warm verzinkt / Galvanisé chaud

MULLER FIX



Bandaardingsklemmen

Bandes pour mise à la terre

BESTELNUMMER N° DE COMMANDE	Afmetingen dimensions	VERP. EMB.
AM 37/0	120 mm	10 / 200
AM 37/1	190 mm	10 / 200
AM 37/4	420 mm	10 / 200
AM 37/6	580 mm	10 / 100

Voor / Pour : 1 x 2,5 mm² à 2 x 6 mm²
Vernikkelde klem + schroef. Inox band.
Clame + écrous nickelées. Bande en inox

MULLER FIX



Moerklemmen (Splitklemmen)

Connecteurs de dérivation

BESTELNUMMER N° DE COMMANDE	ø	VERP. EMB.
AM9200026	6 - 10 mm ²	100
AM9200027	16 mm ²	100
AM9200028	25 mm ²	100
AM9200029	35 mm ²	50
AM9200030	50 mm ²	50

Messing vernikkeld
Laiton nickelé

MULLER FIX



Unimaxklem

Attache-unimax

BESTELNUMMER N° DE COMMANDE	Afmetingen dimensions	VERP. EMB.
AM 9200034	4 - 16 mm	100
AM 9200035	4 - 25 mm	100
AM 9200036	4 - 35 mm	50
AM 9200037	6 - 50 mm	50
AM 9200038	6 - 50 mm	50

Messing vernikkeld / Laiton nickelé



Aardstaven met kopermantel met Schroefdraad

Piquets de terre avec manteau de cuivre à visser

BESTELNUMMER N° DE COMMANDE	Afmetingen dimensions	Normen Normes	Opmerking	VERP. EMB.
AM 117	1500 mm	30μ	ø 16 mm	1 / 10
AM 118	2000 mm	30μ	ø 16 mm	1 / 10
AM 127	1500 mm	30μ	ø 18 mm	1 / 10
AM 128	2000 mm	30μ	ø 18 mm	1 / 10
AM 117/100	1500 mm	100μ	ø 16 mm	1 / 10
AM 118/100	2000 mm	100μ	ø 16 mm	1 / 10
AM 127/100	1500 mm	100μ	ø 18 mm	1 / 10
AM 117/250	1500 mm	250μ	ø 18 mm	*
AM 118/250	2000 mm	250μ	ø 16 mm	*

*OP AANVRAAG / SUR DEMANDE

MET SCHROEFDRAAD/ A VISSER

MULLER FIX



Moffen

Manchons

BESTELNUMMER N° DE COMMANDE	∅	VERP. EMB.
AM M116	16 mm	10
AM M126	18 mm	60 / 240
AMMB116	16 mm	1/240

Koper / Cuivre

MET SCHROEFDRAAD/ A VISSER

MULLER FIX



Aardstaven met kopermantel conisch - 30 μ

Piquets manteau cuivre conique - 30 μ

BESTELNUMMER N° DE COMMANDE	Spécificité Specificiteit	Lengte Longueur	∅	Temp.couleur Kleur Temp.	VERP. EMB.
AM114SS	30 μm	1500 mm	14,0 mm	1	10 / 500

CONISCH / CÔNIQUE



Moffen conisch

Manchons cônica

BESTELNUMMER N° DE COMMANDE	∅	Temp.couleur Kleur Temp.	VERP. EMB.
AMM116-C	14 mm	1	1/100

Messing / Laiton



Klemmen verkoperd

Clames cuivré

BESTELNUMMER N° DE COMMANDE	Afmetingen dimensions	Grondstof	Matière	VERP. EMB.
AM S116	16 mm	Koper	Cuivre	10 / 260
AM S126	18 mm	Koper	Cuivre	100
AMSB116	16 mm	Verkoperd metaal	Acier cuivré	100

MULLER FIX



Design radiatorklemmen

Clame de terre pour écrou de radiateur

BESTELNUMMER N° DE COMMANDE	Afmetingen dimensions	Grondstof	Matière	VERP. EMB.
9260030	30 mm	Messing -Vernikkeld	Laiton Nickelé	5



Handslagijzers

Têtes de frappe

BESTELNUMMER N° DE COMMANDE	Afmetingen dimensions
AM T116	16 mm
AM T126	18 mm

MULLER FIX



Handslagbout

Boulons de frappe

BESTELNUMMER N° DE COMMANDE	ø	Temp.couleur Kleur Temp.	VERP. EMB.
AMDS16	16 mm	1	1/100
AMDS18	18 mm	1	1/100

MULLER FIX



Aardingsonderbrekers + rail voor dito

Coupures de terre + rail pour dito

BESTELNUMMER N° DE COMMANDE
AM 0301
AM 0303
AM 0305

MULLER FIX



KLAUW

GRIFFE

BESTELNUMMER N° DE COMMANDE	VERP. EMB.
AM K0310	100

MULLER FIX



Aard-nulrail 16 mm²

Bornier de répartition 16 mm²

BESTELNUMMER N° DE COMMANDE	Afmetingen dimensions	Nbr. LED Aantal LED	VERP. EMB.
AM 200172	10 x 8 mm	144 bornes M5	1

Lengthe 1 meter / Longueur 1 mètre
144 aansluitingen M5 Vernikkeld messing / 144 bornes M5 Laiton nickelé



Klauwklemmen

Borniers à griffes

BESTELNUMMER N° DE COMMANDE	Spécificité Specificiteit	∅	Temp.couleur Kleur Temp.	VERP. EMB.
AMCC1016	*1	< 16 mm ²	1	1
AMCC2550	*1	< 50 mm ²	1	1
AMCC-D-1016	*2	< 16 mm ²	1	1
AMCC-D-2550	*2	< 50 mm ²	1	1

MULLER FIX



Stekkers

Fiches mâles

BESTELNUMMER N° DE COMMANDE	Stroomsterkte Ampérage	Spaning tension	Normen Normes	VERP. EMB.
679316/4	16A	250 V	IP67	10
679332/4	32A	250 V	IP67	10
679363/8	63A	250 V	IP67	1
679416/4	16A	415 V	IP67	10
679432/4	32A	415 V	IP67	10
679463/8	63A	415 V	IP67	1
679516/4	16A	415 V	IP67	10
679532/4	32A	415 V	IP67	10
679563/8	63A	415 V	IP67	1



Koppelstekkers

Fiches femelles

BESTELNUMMER N° DE COMMANDE	Stroomsterkte Ampérage	Spaning tension	Normen Normes	VERP. EMB.
679316/3	16A	250 V	IP67	10
679332/3	32A	250 V	IP67	10
679363/7	63A	250 V	IP67	1
679416/3	16A	415 V	IP67	10
679432/3	32A	415 V	IP67	10
679463/7	63A	415 V	IP67	1
679516/3	16A	415 V	IP67	10
679532/3	32A	415 V	IP67	10
679563/7	63A	415 V	IP67	1



Wandozen

Prises murales

BESTELNUMMER N° DE COMMANDE	Stroomsterkte Ampérage	Spaning tension	Normen Normes	VERP. EMB.
679316/2	16A	250 V	IP67	10
679332/2	32A	250 V	IP67	10
679363/6	63A	250 V	IP67	1
679416/2	16A	415 V	IP67	10
679432/2	32A	415 V	IP67	10
679463/6	63A	415 V	IP67	1
679516/2	16A	415 V	IP67	10



Wandozen

Prises murales

BESTELNUMMER N° DE COMMANDE	Stroomsterkte Ampérage	Spaning tension	Normen Normes	VERP. EMB.
679532/2	32A	415 V	IP67	10
679563/6	63A	415 V	IP67	1



Inbouwdozen

Prises à encastrer

BESTELNUMMER N° DE COMMANDE	Stroomsterkte Ampérage	Spaning tension	Normen Normes	VERP. EMB.
679316/1	16A	250 V	IP67	10
679332/1	32A	250 V	IP67	10
679363/5	63A	250 V	IP67	1
679516/1	16A	415 V	IP67	10
679532/1	32A	415 V	IP67	10
679563/5	63A	415 V	IP67	1
679416/1	16A	415 V	IP67	10
679432/1	32A	415 V	IP67	10
679463/5	63A	415 V	IP67	1



Stekker in rubber - IP44

Prise femelle en caoutchouc - IP44

BESTELNUMMER N° DE COMMANDE	Temp.couleur Kleur Temp.	VERP. EMB.
C403	1	1/50

10/16A IP44
Normes
250V - Norm7 - TUV



Rubber Koppelsteker - IP44

Prise femelle en caoutchouc - IP44

BESTELNUMMER N° DE COMMANDE	Temp.couleur Kleur Temp.	VERP. EMB.
C404	1	1/40

250V - Norm7 - VDE ; 10/16A - IP44



Stekker in rubber - IP20

Prise mâle en caoutchouc - IP20

BESTELNUMMER N° DE COMMANDE	Spécificité Specificiteit	Temp.couleur Kleur Temp.	VERP. EMB.
C310B	Black	1	1/25
C310W	White	1	1/25

IP20 - 250V - IEC60884 - DIN49441



Rubbere koppelstekker - IP20

Prise femelle en caoutchouc - IP20

BESTELNUMMER N° DE COMMANDE	Spécificité Specificiteit	Temp.couleur Kleur Temp.	VERP. EMB.
C311B	Black	1	1/24
C311W	White		1/24

IP20 - 250V - IEC60884 - DIN49441



PVC koppelstekker - IP20

Prise mâle PVC - IP20

BESTELNUMMER N° DE COMMANDE	Spécificité Specificiteit	Temp.couleur Kleur Temp.	VERP. EMB.
C300B	Black	1	1/25
C300W	White	1	1/25

IP20 - 250V - IEC60884 - DIN49441



Stekker

Fiches plates

BESTELNUMMER N° DE COMMANDE	Spécificité Specificiteit	Temp.couleur Kleur Temp.	VERP. EMB.
C320B	Black	1	1/48
C320W	White	1	1/48
C321B	Black	1	1/48
C321W	White	1	1/48

10A IEC 60884
 250V EN 50075
 320* 321*
 Mannelijk Vrouwelijk
 Mâle Femelle



VERLENGSNOEREN EN KABELHASPELS ENROULEUR DE CÂBLE

KABEL

CABLE

BESTELNUMMER N° DE COMMANDE	Spécificité Specificiteit	Stroomsterkte Ampérage	Spaning tension	Polen Poles	Normen Normes
SN25H07R3G2.5	H07RN-F 3G2.5	10/16A	250V	3P	IP44
SN25H07R3G2.5TRI	H07R3G2.5*	3x10/16A	250V	3P	IP44
SN25H07R5G6	H07RN-F 5G6	32A	400V	5P	CEE IP44
SN25H07R5G16	H07RN-F 5G16	63A	400V	5P	

Verlengsnoer 25m / Rallonge 25 m

*Drievoudig

*Triple

Verlengsnoeren op maat

Rallonge sur mesure



VERLENGSNOER RUBBER

RALLONGE CAOUTCHOUC

BESTELNUMMER N° DE COMMANDE	Lengte Longueur	VERP. EMB.
MFVS10	10m	1
MFVS15	15m	1
MFVS20	20m	1
MFVS25	25m	1
MFVS30	30m	1
MFVS40	40m	1
MFVS50	50m	1

H07RN-F, 3G2.5, IP44, 16A, 250V



PROFESSIONELE KABELHASPEL

ENROULEUR PROFESSIONNEL

BESTELNUMMER N° DE COMMANDE	Lengte Longueur	VERP. EMB.
MFR253G25	25m	1
MFR403G25	40m	1

4 prises/stopcontacten, IP44, H07RN-F, 25m, 3G2.5, 16A, 250V, 3600W



VERLENGSNOEREN EN KABELHASPELS ROULEUR DE CÂBLE

PROFESSIONELE MEERVOUDIGE STEKKERBLOK

SOCLE MULTIPRISES PROFESSIONNEL

BESTELNUMMER N° DE COMMANDE	VERP. EMB.
MFM46	1

4 prises/stopcontacten, IP44, H07RN-F, 6m, 3G2.5, 16A, 250V



INBOUW STOPCONTACT MET KLAPDEKSEL

PRISE A CLAPET A ENCASTRER

BESTELNUMMER N° DE COMMANDE	VERP. EMB.
MFPS17	1

blauw, penoording, IP44, 16A, 250V
bleu, broche de terre

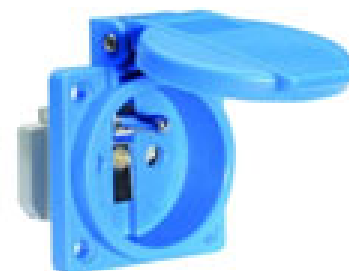

DOOS VOOR STEKKERVERBINDING, IP44

BOÎTIER POUR RACCORD DE PRISES, IP44

BESTELNUMMER N° DE COMMANDE	VERP. EMB.
MFBOX01	1

CE, RoHS, REACH, PAHS



W4-16

BESTELNUMMER N° DE COMMANDE	∅	VERP. EMB.
W4-16	4 - 16 mm ²	1/12

Met haakkling voor verwijdering van de isolatie.
Avec lame spéciale pour écarter l'isolation.



W8-28

BESTELNUMMER N° DE COMMANDE	∅	VERP. EMB.
W8-27	8 - 28 mm ²	1/12

Met haakkling voor verwijdering van de isolatie.
Avec lame spéciale pour écarter l'isolation.



W50

BESTELNUMMER N° DE COMMANDE	∅	∅ IN	VERP. EMB.
W50	35 - 50 mm ²	35 - 50	1/12



W1000

BESTELNUMMER N° DE COMMANDE	VERP. EMB.
W1000	1/12

Met haakkling voor verwijdering van de isolatie.
Avec lame spéciale pour écarter l'isolation.



WBLI28H4

BESTELNUMMER N° DE COMMANDE	ø	VERP. EMB.
WBLI28H4	4 - 28 mm	1/12

Met haakkling voor verwijdering van de isolatie.
Avec lame spéciale pour écarter l'isolation.



WBLIS428

BESTELNUMMER N° DE COMMANDE	ø	VERP. EMB.
WBLIS428	4 - 28 mm	1/12

Gemoderniseerde versie van de BLI28H. Met inklapbaar mes.
Version modernisée du BLI28H. Avec lame retractable,



W10

BESTELNUMMER N° DE COMMANDE	VERP. EMB.
W10	1

Vervangmesje voor 16 - 27 - 50 - BLI28H
Lame de réchange pour 16 - 27 - 50 - BLI28H

W10.1

BESTELNUMMER N° DE COMMANDE	VERP. EMB.
W10.1	1

Vervangmesje voor BLIS428
Lame de réchange pour BLIS428

W100

BESTELNUMMER N° DE COMMANDE	VERP. EMB.
W100	1/12

Ontmantelmes + striptang.
Couteau à démanteler + dénuder.



WBLI13

BESTELNUMMER N° DE COMMANDE	∅	VERP. EMB.
WBLI13	6 - 13 mm	1/ 12

Ontmantelingsmes ronde kabel van 3 x 1,5 mm tot 5 x 2,5 mm.
 Buitendiameter : 6 tot 13 mm.
 Couteau à démanteler pour câbles ronds de 3 x 1,5 mm² à 5 x 2,5 mm.
 Diamètre extérieur : 6 à 13 mm.



W16

BESTELNUMMER N° DE COMMANDE	∅	∅ IN	VERP. EMB.
W16	8 - 13 mm ²	4 - 16	1/12

Quadro Ontmantelingsmes, haakmes inklapbaar, strippen 0,5 tot 6mm²
 Quadro Couteau a demanteler, lame en crochet retractable, dénudeur
 0,5 jusqu'au 6mm²



W30

BESTELNUMMER N° DE COMMANDE	∅	VERP. EMB.
W30	4 - 10 mm	1/12

Data - Strip Ontmantelingsmes voor data kabel, strippen 0,2 - 0,8mm²
 Data Strip - Couteau à demanteler pour câble data, coupe-fil jusqu'à Ø 8 mm, dénudeur 0,2 - 0,8 mm²



W25

BESTELNUMMER N° DE COMMANDE	∅	VERP. EMB.
W25	25 mm	1/6

Ontmantelingsmes voor grondkabel, Ø = 25mm (zowel dwars als in de lengte), tot manteldikte 5mm
 Couteau à demanteler pour cable de sol, Ø = 25 mm (circulaire et longitudinal), jusqu'à 5mm d'épaisseur

**Striptang SUPER**

Pince à dénuder SUPER

BESTELNUMMER N° DE COMMANDE	∅	VERP. EMB.
WBL15	0,2-6 mm	1/6

**Tang DUO CRIMP**

Pince DUO CRIMP

BESTELNUMMER N° DE COMMANDE	∅	VERP. EMB.
W300	0,5-6 mm	1/6



MULTI-STRIPPER

MULTI-STRIPPER

BESTELNUMMER N° DE COMMANDE	∅	VERP. EMB.
W400	8-13 mm	1/6

**MULTI-STRIPPER PLUS**

MULTI-STRIPPER PLUS

BESTELNUMMER N° DE COMMANDE	∅	VERP. EMB.
W500	0,5-6 mm	1/12

Strippen + knippen + krimpen.
Dénuder + couper +sertir.

**Striptangen SOLAR**

Pincès à dénuder SOLAR

BESTELNUMMER N° DE COMMANDE	∅	VERP. EMB.
WBLI3SOLAR	1,5 - 6 mm ²	1
WBLI7SOLAR	1,5 - 6 mm ²	1

Speciaal voor zonne-energietechniek.
Spécialement pour le technique énergie solaire.



Buistang Voor het knippen van PVC-buizen 16 mm en 20 mm

Pince pour couper tubes Pour couper tubes en PVC de 16 mm et

BESTELNUMMER N° DE COMMANDE	VERP. EMB.
KT3204	1

Voor het knippen van PVC-buizen
16 mm en 20 mm.
Pour couper tubes en PVC de
16 mm et 20 mm.

**Reserve onderbasis tang 3204**

Base de rechange pour pince 3204

BESTELNUMMER N° DE COMMANDE	VERP. EMB.
KT3002-3204	1

**Reservemesje tangen 3204 en 3704**

Lame de rechange pour pinces 3204 et 3704

BESTELNUMMER N° DE COMMANDE	VERP. EMB.
KT3001	1



Metaal - Rond

Métal - Rond

BESTELNUMMER N° DE COMMANDE	Lengte Longueur	VERP. EMB.
305505	5 m	1/20
305510	10 m	1/15
305515	15 m	1/10
305520	20 m	1/8
305525	25 m	1/6
305530	30 m	1/5

**Metaal - Plat**

Métal - Plat

BESTELNUMMER N° DE COMMANDE	Lengte Longueur	VERP. EMB.
11405	5 m	1/10
11410	10 m	1/10
11415	15 m	1/10
11420	20 m	1/10
11425	25 m	1/10
11430	30 m	1/10

**Nylon**

Nylon

BESTELNUMMER N° DE COMMANDE	Lengte Longueur	VERP. EMB.
11605	5 m	1/25
11610	10 m	1/20
11615	15 m	1/12
11620	20 m	1/10
11625	25 m	1/8
11630	30 m	1/6



Glasfiber

Fibre de verre

BESTELNUMMER N° DE COMMANDE	Lengte Longueur	ø IN	Flux Nom. Nom. Stroom
37000	30 m	3,5 mm	A
37010	50 m	4,5 mm	A
37020	60 m	6 mm	A
37030	80 m	6 mm	A
37040	100 m	6 mm	A
37050	60 m	9 mm	A
37060	100 m	9 mm	A
37070	120 m	9 mm	A
37080	150 m	11 mm	A
37090	30 m	3,5 mm	B
37100	50 m	4,5 mm	C
37110	60 m	6 mm	C
37120	80 m	6 mm	C
37130	100 m	6 mm	C
37140	60 m	9 mm	C
37150	100 m	9 mm	C
37160	120 m	9 mm	C
37170	150 m	11 mm	C



Op bestelling / sur commande



Toebehoren voor trekveren

Accessoires pour tire-fils

BESTELNUMMER N° DE COMMANDE	VERP. EMB.
Spirado	1
Spiratrek	1



160 cm

160 cm

BESTELNUMMER N° DE COMMANDE	Lengte Longueur	ø	VERP. EMB.
310816	80 cm	16 mm	1
310820	80 cm	20 mm	1
310825	80 cm	25 mm	1

Versterkte uitvoering.
Staaldraad 2 x 2 mm.
Exécution renforcée.
Fil en acier 2 x 2 mm.

**80 cm**

80 cm

BESTELNUMMER N° DE COMMANDE	Lengte Longueur	ø	VERP. EMB.
311616	160 cm	16 mm	1
311620	160 cm	20 mm	1
311625	160 cm	25 mm	1

Versterkte uitvoering.
Staaldraad 2 x 2 mm.
Exécution renforcée.
Fil en acier 2 x 2 mm.

**Diamantdroogzagen**

Disques diamantes (performer)

BESTELNUMMER N° DE COMMANDE	Afmetingen dimensions	VERP. EMB.
DX 440125	125 x 22,2 mm	1
DX 440150	150 x 22,2 mm	1
DX 440180	180 x 22,2 mm	1
DX 440230	230 x 22,2 mm	1

Performer / Pro Construction



Diamant droogboren zonder stofafzuiging voor baksteen

Couronnes diamantes sans poussiere pour brique

BESTELNUMMER N° DE COMMANDE	Afmetingen dimensions	VERP. EMB.
DX 803102	ø 102 mm	1

Diamant doosboor - CD-D150. Trépans diamanté - CD-D150



Diamant droogboren zonder stofafzuiging voor baksteen

Couronnes diamantes sans poussiere pour brique

BESTELNUMMER N° DE COMMANDE	Afmetingen dimensions	VERP. EMB.
DX 805102	ø 102 mm	1

Diamant doosboor - CD-D150. Trépans diamanté - CD-D150



Diamant natboren voor beton en gewapend beton

Couronnes diamantées pour béton et béton armé

BESTELNUMMER N° DE COMMANDE	Afmetingen dimensions	VERP. EMB.
DX 912052	Ø 52 mm	1
DX 912057	Ø 57 mm	1
DX 912062	Ø 62 mm	1
DX 912067	Ø 67 mm	1
DX 912072	Ø 72 mm	1
DX 912082	Ø 82 mm	1
DX 912087	Ø 87 mm	1
DX 912092	Ø 92 mm	1
DX 912102	Ø 102 mm	1
DX 912112	Ø 112 mm	1
DX 912122	Ø 122 mm	1
DX 912132	Ø 132 mm	1
DX 912142	Ø 142 mm	1
DX 912152	Ø 152 mm	1
DX 912160	Ø 160 mm	1
DX 912170	Ø 170 mm	1

Diamant doosboor - CD-D150. Trépans diamanté - CD-D150



Diamant natboren voor beton en gewapend beton

Couronnes diamantées pour béton et béton armé

BESTELNUMMER N° DE COMMANDE	Afmetingen dimensions	VERP. EMB.
DX 912180	Ø 180 mm	1
DX 912200	Ø 200 mm	1
DX 912220	Ø 220 mm	1
DX 912250	Ø 250 mm	1
DX 912300	Ø 300 mm	1
DX 912350	Ø 350 mm	1

Diamant doosboor - CD-D150. Trépans diamanté - CD-D150



Snijschijven

Disque à couper

BESTELNUMMER N° DE COMMANDE	Afmetingen dimensions
DX 022115	Ø 115 x 1 mm
DX 022125	Ø 125 x 1 mm
DX 022230	Ø 230 x 1,9 mm

Snijschijf INOX/STAAL A60X-BF / Premium Construction
Disque abrasif INOX A60X-BF / Premium Construction



Snijschijven - BOX

Disque à couper - BOX

BESTELNUMMER N° DE COMMANDE	Afmetingen dimensions
DX 022117-BOX	Ø 115 x 1 mm
DX 022127-BOX	Ø 125 x 1 mm

Snijschijf INOX/STAAL A60X-BF / Premium Construction Box 10 stuks
Disque abrasif INOX A60X-BF / Premium Construction Box 10 pcs



Gatzagen 38 mm

Scies tréfans 38 mm

BESTELNUMMER N° DE COMMANDE	Afmetingen dimensions	VERP. EMB.
SR 27011100	111 mm	1
SR 27001600	16 mm	1
SR 27001900	19 mm	1
SR 27002000	20 mm	1
SR 27002200	22 mm	1
SR 27002500	25 mm	1
SR 27002700	27 mm	1
SR 27002900	29 mm	1
SR 27003000	30 mm	1
SR 27003200	32 mm	1
SR 27003500	35 mm	1
SR 27003800	38 mm	1
SR 27004000	40 mm	1
SR 27004100	41 mm	1
SR 27004300	43 mm	1
SR 27004400	44 mm	1
SR 27004600	46 mm	1
SR 27004800	48 mm	1
SR 27005100	51 mm	1
SR 27005200	52 mm	1
SR 27005400	54 mm	1
SR 27005700	57 mm	1
SR 27005800	58 mm	1
SR 27006000	60 mm	1
SR 27006400	64 mm	1
SR 27006700	67 mm	1
SR 27006800	68 mm	1
SR 27007000	70 mm	1
SR 27007300	73 mm	1
SR 27007400	74 mm	1
SR 27007600	76 mm	1
SR 27007900	79 mm	1
SR 27008300	83 mm	1
SR 27008600	86 mm	1
SR 27008900	89 mm	1
SR 27009200	92 mm	1
SR 27009500	95 mm	1
SR 27009800	98 mm	1
SR 27010200	102 mm	1
SR 27010500	105 mm	1
SR 27010800	108 mm	1
SR 27011400	114 mm	1



Bi-Metalen gatzraag XF3
Scie cloche BI-Metal FX3

Gatzagen 38 mm

Scies tréfans 38 mm

BESTELNUMMER N° DE COMMANDE	Afmetingen dimensions	VERP. EMB.
SR 27012100	121 mm	1
SR 27012700	127 mm	1
SR 27013300	133 mm	1
SR 27014000	140 mm	1
SR 27014600	146 mm	1
SR 27015200	152 mm	1

Bi-Metalen gatzraag XF3
Scie cloche BI-Metal FX3



Gatzagen PREMIUM 38 mm

Scies tréfans PREMIUM 38 mm

BESTELNUMMER N° DE COMMANDE	Afmetingen dimensions	VERP. EMB.
SR 28080014	14 mm	1
SR 28080016	16 mm	1
SR 28080017	17 mm	1
SR 28080019	19 mm	1
SR 28080020	20 mm	1
SR 28080021	21 mm	1
SR 28080022	22 mm	1
SR 28080024	24 mm	1
SR 28080025	25 mm	1
SR 28080027	27 mm	1
SR 28080029	29 mm	1
SR 28080030	30 mm	1
SR 28080032	32 mm	1
SR 28080033	33 mm	1
SR 28080035	35 mm	1
SR 28080037	37 mm	1
SR 28080038	38 mm	1
SR 28080040	40 mm	1
SR 28080041	41 mm	1
SR 28080043	43 mm	1
SR 28080044	44 mm	1
SR 28080046	46 mm	1
SR 28080048	48 mm	1
SR 28080051	51 mm	1
SR 28080052	52 mm	1
SR 28080054	54 mm	1
SR 28080057	57 mm	1
SR 28080059	59 mm	1
SR 28080060	60 mm	1

Bi-Metalen gatzraag SK8 PREMIUM
Scie cloche BI-Metal SK8 PREMIUM



Gatzagen PREMIUM 38 mm

Scies tréfans PREMIUM 38 mm

BESTELNUMMER N° DE COMMANDE	Afmetingen dimensions	VERP. EMB.
SR 28080064	64 mm	1
SR 28080065	65 mm	1
SR 28080067	67 mm	1
SR 28080068	68 mm	1
SR 28080070	70 mm	1
SR 28080073	73 mm	1
SR 28080076	76 mm	1
SR 28080079	79 mm	1
SR 28080083	83 mm	1
SR 28080086	86 mm	1
SR 28080089	89 mm	1
SR 28080092	92 mm	1
SR 28080095	95 mm	1
SR 28080098	98 mm	1
SR 28080102	102 mm	1
SR 28080105	105 mm	1
SR 28080108	108 mm	1
SR 28080111	111 mm	1
SR 28080114	114 mm	1
SR 28080121	121 mm	1
SR 28080127	127 mm	1
SR 28080140	140 mm	1
SR 28080152	152 mm	1



Bi-Metalen gatzaag SK8 PREMIUM
Scie cloche BI-Metal SK8 PREMIUM

Gatzagen 60 mm

Scies tréfans 60 mm

BESTELNUMMER N° DE COMMANDE	Afmetingen dimensions	VERP. EMB.
SR 29555020	20 mm	1
SR 29555022	22 mm	1
SR 29555025	25 mm	1
SR 29555029	29 mm	1
SR 29555030	30 mm	1
SR 29555032	32 mm	1
SR 29555035	35 mm	1
SR 29555038	38 mm	1
SR 29555040	40 mm	1
SR 29555044	44 mm	1
SR 29555050	50 mm	1
SR 29555051	51 mm	1



MULTI TCT gatzaag carbide tipped
MULTI TCT Scie cloche carbide

Gatzagen 60 mm

Scies tréfans 60 mm

BESTELNUMMER N° DE COMMANDE	Afmetingen dimensions	VERP. EMB.
SR 29555054	54 mm	1
SR 29555057	57 mm	1
SR 29555060	60 mm	1
SR 29555063	63 mm	1
SR 29555065	65 mm	1
SR 29555067	67 mm	1
SR 29555068	68 mm	1
SR 29555070	70 mm	1
SR 29555073	73 mm	1
SR 29555076	76 mm	1
SR 29555079	79 mm	1
SR 29555080	80 mm	1
SR 29555082	82 mm	1
SR 29555083	83 mm	1
SR 29555086	86 mm	1
SR 29555089	89 mm	1
SR 29555092	92 mm	1
SR 29555102	102 mm	1
SR 29555105	105 mm	1
SR 29555108	108 mm	1
SR 29555111	111 mm	1
SR 29555114	114 mm	1
SR 29555121	121 mm	1
SR 29555125	125 mm	1
SR 29555127	127 mm	1
SR 29555133	133 mm	1
SR 29555140	140 mm	1
SR 29555152	152 mm	1
SR 29555165	165 mm	1
SR 29555185	185 mm	1

MULTI TCT gatzagaag carbide tipped
MULTI TCT Scie cloche carbide



Centreerboren en houders voor gatzagen

Forets de centrage et mandrins pour scies-trepans

BESTELNUMMER N° DE COMMANDE	ø
SR 29609605	83 mm
SR 29609610	102 mm
SR 29609524	32-210 mm
SR 29609527	32-210 mm



Metaalboren

Forets à métaux

BESTELNUMMER N° DE COMMANDE	ø
SR 22305501	1,00
SR 22305511	1,50
SR 22305520	2,00
SR 22305529	2,50
SR 22305538	3,00
SR 22305547	3,50
SR 22305556	4,00
SR 22305565	4,20
SR 22305574	4,50
SR 22305583	5,00
SR 22305592	5,50
SR 22305601	6,00
SR 22305620	6,50
SR 22305629	7,00
SR 22305638	7,50
SR 22305647	8,00
SR 22305656	8,50
SR 22305665	9,00
SR 22305674	9,50
SR 22305683	10,00
SR 22305692	10,50
SR 22305701	11,00
SR 22305710	11,50
SR 22305719	12,00
SR 22305728	12,50
SR 22305737	13,00



HSS Premium - DIN 338

Metaalboren - BOX

Forets à métaux - BOX

BESTELNUMMER N° DE COMMANDE	∅
SR 22315019	1-10 X 0.5
SR 22315025	1-13 X 0.5

HSS DIN 338 PREMIUM SET Metalbox
HSS DIN 338 PREMIUM SET Box en metal



Steen en betonboren SDS Plus

Forets à pierre et béton SDS Plus

BESTELNUMMER N° DE COMMANDE	∅	VERP. EMB.
SR 24050111	5,0 x 110 mm	1
SR 24060111	6,0 x 110 mm	1
SR 24080111	8,0 x 110 mm	1
SR 24050161	5,0 x 160 mm	1
SR 24060161	6,0 x 160 mm	1
SR 24065161	6,5 x 160 mm	1
SR 24080161	8,0 x 160 mm	1
SR 24100161	10 x 160 mm	1
SR 24120161	12 x 160 mm	1
SR 24140161	14 x 160 mm	1
SR 24160161	16 x 160 mm	1
SR 24060211	6,0 x 210 mm	1
SR 24065211	6,5 x 210 mm	1
SR 24080211	8,0 x 210 mm	1
SR 24100211	10 x 210 mm	1
SR 24120211	12 x 210 mm	1
SR 24140211	14 x 210 mm	1
SR 24160211	16 x 210 mm	1
SR 24180251	18 x 250 mm	1
SR 24200251	20 x 250 mm	1
SR 24220251	22 x 250 mm	1
SR 24240251	24 x 250 mm	1
SR 24300251	30 x 250 mm	1
SR 24050261	5,0 x 260 mm	1
SR 24060261	6,0 x 260 mm	1
SR 24065261	6,5 x 260 mm	1
SR 24080261	8,0 x 260 mm	1
SR 24100261	10 x 260 mm	1
SR 24120261	12 x 260 mm	1
SR 24140261	14 x 260 mm	1

Stenroc SDS-Plus PREMIUM 4-Cutter



Steen en betonboren SDS Plus

Forets à pierre et béton SDS Plus

BESTELNUMMER N° DE COMMANDE	∅	VERP. EMB.
SR 24150261	15 x 260 mm	1
SR 24160261	16 x 260 mm	1
SR 24060311	6,0 x 310 mm	1
SR 24065311	6,5 x 310 mm	1
SR 24080311	8,0 x 310 mm	1
SR 24100311	10 x 310 mm	1
SR 24120311	12 x 310 mm	1
SR 24140311	14 x 310 mm	1
SR 24160311	16 x 310 mm	1
SR 24080361	8,0 x 360 mm	1
SR 24100361	10 x 360 mm	1
SR 24080461	8,0 x 460 mm	1
SR 24100461	10 x 450 mm	1
SR 24120461	12 x 450 mm	1
SR 24140461	14 x 450 mm	1
SR 24160461	16 x 450 mm	1
SR 24180461	18 x 460 mm	1
SR 24200461	20 x 450 mm	1
SR 24220461	22 x 450 mm	1
SR 24240461	24 x 450 mm	1
SR 24280461	28 x 450 mm	1
SR 24300451	30 x 450 mm	1
SR 24320451	32 x 450 mm	1
SR 24100601	10 x 600 mm	1
SR 24120601	12 x 600 mm	1
SR 24140601	14 x 600 mm	1
SR 24160601	16 x 600 mm	1
SR 24100951	10 x 1000 mm	1
SR 24120951	12 x 1000 mm	1
SR 24140951	14 x 1000 mm	1
SR 24160951	16 x 1000 mm	1
SR 24180951	18 x 1000 mm	1
SR 24200951	20 x 1000 mm	1

Stenroc SDS-Plus PREMIUM 4-Cutter



Steen en betonboren SDS Max

Forets à pierre et béton SDS Max

BESTELNUMMER N° DE COMMANDE	ø	VERP. EMB.
SR 23140340	14 x 340 mm	1
SR 23150340	15 x 340 mm	1
SR 23200320	20 x 320 mm	1
SR 23220320	22 x 320 mm	1
SR 23240320	24 x 320 mm	1
SR 23250320	25 x 320 mm	1
SR 23280370	28 x 370 mm	1
SR 23300370	30 x 370 mm	1
SR 23320370	32 x 370 mm	1
SR 23120540	12 x 540 mm	1
SR 23140540	14 x 540 mm	1
SR 23160540	16 x 540 mm	1
SR 23180540	18 x 540 mm	1
SR 23200520	20 x 520 mm	1
SR 23220520	22 x 520 mm	1
SR 23240520	24 x 520 mm	1
SR 23250520	25 x 520 mm	1
SR 23260520	26 x 520 mm	1
SR 23280570	28 x 570 mm	1
SR 23300570	30 x 570 mm	1
SR 23320570	32 x 570 mm	1
SR 23350570	35 x 570 mm	1
SR 23380570	38 x 570 mm	1
SR 23400570	40 x 570 mm	1
SR 23450570	45 x 570 mm	1
SR 23500570	50 x 570 mm	1
SR 23520570	52 x 570 mm	1
SR 23280670	28 x 670 mm	1
SR 23350670	35 x 670 mm	1
SR 23160940	16 x 940 mm	1
SR 23180940	18 x 940 mm	1
SR 23200920	20 x 920 mm	1
SR 23220920	22 x 920 mm	1
SR 23250920	25 x 920 mm	1
SR 23280920	28 x 920 mm	1
SR 23300920	30 x 920 mm	1
SR 23320920	32 x 920 mm	1
SR 23350920	35 x 920 mm	1
SR 23400920	40 x 920 mm	1
SR 23251320	25 x 1320 mm	1
SR 23281320	28 x 1320 mm	1
SR 23321320	32 x 1320 mm	1
SR 23351320	35 x 1320 mm	1

Stenroc SDS-Max PREMIUM 4-Cutter



Steen en betonboren SDS Max

Forets à pierre et béton SDS Max

BESTELNUMMER N° DE COMMANDE	∅	VERP. EMB.
SR 23401320	40 x 1320 mm	1

Stenroc SDS-Max PREMIUM 4-Cutter



Tapboren

Forêt étagés

BESTELNUMMER N° DE COMMANDE	∅
SR 22400100	4/5/6/7/8/9/10/11/12
SR 22400120	6/8/10/12/14/16/18/20
SR 22400154	6/8/10/12/14/16/18/20/22/24/26/28/30
SR 22400185	7/12.5/15.2/18.6/20.4/22.5/28.3/37

Trapboor HSS-G - PREMIUM
Forêt étagés HSS-G - PREMIUM



Houtboren

Meche à bois

BESTELNUMMER N° DE COMMANDE	∅
SR 26001005	4/5/6/8/10
SR 26001018	3 - 10 mm

WOOD Houtboorset SET
WOOD Set de mèches à bois



Platte boor

Mèche platte pour bois

BESTELNUMMER N° DE COMMANDE	ø	VERP. EMB.
SR 26802008	8 x 152 mm	1
SR 26802010	10 x 152 mm	1
SR 26802012	12 x 152 mm	1
SR 26802014	14 x 152 mm	1
SR 26802016	16 x 152 mm	1
SR 26802018	18 x 152 mm	1
SR 26802020	20 x 152 mm	1
SR 26802022	22 x 152 mm	1
SR 26802024	24 x 152 mm	1
SR 26802025	25 x 152 mm	1
SR 26802028	28 x 152 mm	1
SR 26802030	30 x 152 mm	1
SR 26802032	32 x 152 mm	1
SR 26802035	35 x 152 mm	1
SR 26802038	38 x 152 mm	1
SR 26802040	40 x 152 mm	1
SR 26814408	8 x 400 mm	1
SR 26814410	10 x 400 mm	1
SR 26814412	12 x 400 mm	1
SR 26814414	14 x 400 mm	1
SR 26814418	18 x 400 mm	1
SR 26814420	20 x 400 mm	1
SR 26814422	22 x 400 mm	1
SR 26814428	28 x 400 mm	1
SR 26814430	30 x 400 mm	1
SR 26814435	35 x 400 mm	1

Grey Star - FLATWOOD platte houtboor
Grey Star - FLATWOOD mèche platte bois



Platte boor - Set

Mèche platte pour bois - Set

BESTELNUMMER N° DE COMMANDE	Afmetingen dimensions
SR 26825000	152 mm

RED POINT - FLATWOOD SET 12,16,18,20,22,25,28,32 x 152 mm



Kabeltrekker met 3-voudig getorste kabel

Tire-fil avec cable triplement torsadé

BESTELNUMMER N° DE COMMANDE	∅	VERP. EMB.
RT 10014	5,3 mm	1

RUNPO 30 m - ∅ 5,3 mm + 2 x Runpoglider

**Kabeltrekker met behuizing in glasvezel**

Tire-fil avec en fibre de verre sous boitier

BESTELNUMMER N° DE COMMANDE	Lengte Longueur	∅	VERP. EMB.
RT 100087	20 m	7 mm	1
RT 100090	50 m	7 mm	1

POWER REX - ∅ 3 mm + 1 x Runpoglider ∅ 7 mm

**Toebehoren Power Rex**

Accessoires Power Rex

BESTELNUMMER N° DE COMMANDE	∅	VERP. EMB.
RT 20116	7 mm	1
RT 20303	10 mm	1
RT 20119	13 mm	1

Flexibele glijkop - RTG ∅ 6 mm
Tête de passage flexible - RTG ∅ 6 mm

RUNPO Z

RUNPO Z

BESTELNUMMER N° DE COMMANDE	Afmetingen dimensions	∅	VERP. EMB.
RT 20273	310 mm	6-9 mm	1
RT 20274	460 mm	9-15 mm	1

RUNPO Z - kabeltrekker
RUNPO Z - tire-câble



BAMBURGH

BAMBURGH

BESTELNUMMER N° DE COMMANDE	Spécificité Specificiteit	Omschr.	Descr.	Stroomsterkte Ampérage	Vermogen Puissance	VERP. EMB.
VEN-AMY005-KITB-EM	BLACK	met noodverlichting	avec secours	0,08 A	14 W	1
VEN-AMY005-KITB	BLACK			0,08 A	14 W	1
VEN-AMY005-KITB-SM-EM	BLACK	met HFSensor en noodverlichting	avec capteur HF et secours	0,08 A	14 W	1
VEN-AMY005-KITB-SM	BLACK	met HFSensor	avec capteur HF	0,08 A	14 W	1
VEN-AMY006-KITB-EM	BLACK	met noodverlichting	avec secours	0,1 A	20 W	1
VEN-AMY006-KITB	BLACK	met HFSensor	avec capteur HF	0,1 A	20 W	1
VEN-AMY006-KITB-SM-EM	BLACK	met HFSensor en noodverlichting	avec capteur HF et secours	0,1 A	20 W	1
VEN-AMY006-KITB-SM	BLACK	met HFSensor	avec capteur HF	0,1 A	20 W	1
VEN-AMY005-KITBE-EM	BLACK	met noodverlichting	avec secours	0,08 A	14 W	1
VEN-AMY005-KITBE	BLACK	met ooglid	avec paupière	0,08 A	14 W	1
VEN-AMY005-KITBE-SM-EM	BLACK	met HFSensor en noodverlichting met ooglid	avec capteur HF et secours, avec paupière	0,08 A	14 W	1
VEN-AMY005-KITBE-SM	BLACK	met HFSensor, met ooglid	avec capteur HF, avec paupière	0,08 A	14 W	1
VEN-AMY006-KITBE-EM	BLACK	met noodverlichting met ooglid	avec secours, avec paupière	0,1 A	20 W	1
VEN-AMY006-KITBE	BLACK	met HFSensor, met ooglid	avec capteur HF, avec paupière	0,1 A	20 W	1
VEN-AMY006-KITBE-SM-EM	BLACK	met HFSensor en noodverlichting met ooglid	avec capteur HF et secours, avec paupière	0,1 A	20 W	1
VEN-AMY006-KITBE-SM	BLACK	met HFSensor, met ooglid	avec capteur HF, avec paupière	0,1 A	20 W	1
VEN-AMY005-KITBG-EM	BLACK	met noodverlichting met rooster	avec secours, avec grille	0,08 A	14 W	1
VEN-AMY005-KITBG	BLACK	met rooster	avec grille	0,08 A	14 W	1
VEN-AMY005-KITBG-SM-EM	BLACK	met noodverlichting met rooster, HFSensor	avec capteur HF, avec secours, avec grille	0,08 A	14 W	1



Ronde LED-verlichting voor binnen- en buitenshuis voor plafond en wand
 220-240 V
 IP65
 4000 K
 Luminaire LED rond pour intérieur et extérieur pour plafond/mur intérieur et extérieur
 Ø 350 x 90 mm

BAMBURGH

BAMBURGH

BESTELNUMMER N° DE COMMANDE	Spécificité Specificiteit	Omschr.	Descr.	Stroomsterkte Ampérage	Vermogen Puissance	VERP. EMB.
VEN-AMY005-KITBG-SM	BLACK	met microgolfsensor met rooster	avec capteur à micro-ondes, avec grille	0,08 A	14 W	1
VEN-AMY006-KITBG-EM	BLACK	met noodverlichting met rooster	avec secours, avec grille	0,1 A	20 W	1
VEN-AMY006-KITBG	BLACK	met rooster	avec grille	0,1 A	20 W	1
VEN-AMY006-KITBG-SM-EM	BLACK	met microgolfsensor en noodverlichting met rooster	avec capteur à micro-ondes et secours, avec grille	0,1 A	20 W	1
VEN-AMY006-KITBG-SM	BLACK	met HFsensor, met rooster	avec capteur HF, avec grille	0,1 A	20 W	1
VEN-AMY005-KITW-EM	WHITE	met noodverlichting	avec secours	0,08 A	14 W	1
VEN-AMY005-KITW	WHITE			0,08 A	14 W	1
VEN-AMY005-KITW-SM-EM	WHITE	met HFsensor en noodverlichting	avec capteur à micro-ondes et secours	0,08 A	14 W	1
VEN-AMY005-KITW-SM	WHITE	met HFsensor	avec capteur HF	0,08 A	14 W	1
VEN-AMY006-KITW-EM	WHITE	met noodverlichting	avec secours	0,1 A	20 W	1
VEN-AMY006-KITW	WHITE	met HFsensor	avec capteur HF	0,1 A	20 W	1
VEN-AMY006-KITW-SM-EM	WHITE	met HFsensor en noodverlichting	avec capteur HF et secours	0,1 A	20 W	1
VEN-AMY006-KITW-SM	WHITE	met HFsensor	avec capteur HF	0,1 A	20 W	1

Ronde LED-verlichting voor binnen- en buitenshuis voor plafond en wand
 220-240 V
 IP65
 4000 K
 Luminaire LED rond pour intérieur et extérieur pour plafond/mur intérieur et extérieur
 Ø 350 x 90 mm



Kelderverlichtingen

Hublots

BESTELNUMMER N° DE COMMANDE	Spécificité Specificiteit	Vermogen Puissance	VERP. EMB.
471	3	60 W	1/24
470	2	100 W	1/18
460	1	100 W	1/30

Voet : PVC / Pied : PVC

Glas : Polycarbonaat / onbreekbaar / Verre : Polycarbonate / incassable



BS100 LED ADJUSTABLE

BS100 LED ADJUSTABLE

BESTELNUMMER N° DE COMMANDE	Lengte Longueur	Vermogen Puissance	Flux Nom. Nom. Stroom	Temp.couleur Kleur Temp.	VERP. EMB.
B40003	670 mm	25W - 32W - 36W - 41W	3500lm - 4500lm - 5000lm - 5500lm	4000K	1
B40004	1280 mm	39W - 44W - 47W - 53W	5500lm - 6000lm - 6500lm - 7000lm	4000K	1
B40005	1580 mm	45W - 50W - 53W - 59W	6500lm - 7000lm - 7500lm - 8000lm	4000K	1



noodverlichtingsmodule - voor BS100

Module de secours - pour BS100

BESTELNUMMER N° DE COMMANDE	VERP. EMB.
b19358	1

SA/SE : Permanent/Niet Permanent 1uur

SA/SE : Permanent/Non Permanent 1 heure

BS100 LED Adjustable - Kit

BS100 LED Adjustable - Kit

BESTELNUMMER N° DE COMMANDE	Spécificité Specificiteit	Afmetingen dimensions	Vermogen Puissance	Flux Nom. Nom. Stroom	Temp.coule Kleur Temp.	VERP. EMB.
KIT-B40004		1280 x170x95 mm	39W - 44W - 47W - 53W	5500lm - 6000lm - 6500lm - 7000lm	4000K	1
KIT-B40004-SEC	*1	1280 x170x95 mm	39W - 44W - 47W - 53W	5500lm - 6000lm - 6500lm - 7000lm	4000K	1
KIT-FILTREVERT	*2	1280 x170 mm				1



Professioneel waterdicht verlichtingsarmatuur

Zeer hoge lichtstroom

4 lichtsterktes, regelbaar via dipswitch

Doorluskabel 0,5m H07R3G15 aan ingang

Doorluskabel 10m H07R3G15 aan uitgang

Wieland stekkers 3p 250V 20A

Op vraag ook verkrijgbaar met CEE of normale IP44 aansluiting

IP65

Module noodverlichting verkrijgbaar op aanvraag

Maximum 20 toestellen in 1 lijn

Op maat bekabeling mogelijk

*1 Module Noodverlichting

*2 Groene filter op aanvraag

Luminaire professionnel étanche

Flux lumineux élevé

4 outputs lumineux, réglable via dipswitch

Câble 0,5 m H07R3G15 côté entrée

Câble 10m H07R3G15 côté sortie

Connections Wieland 3p 250V 20A

Raccordement CEE ou standard IP44 disponible sur demande

IP65

Module secours disponible sur demande

Maximum 20 appareils sur une ligne

Possibilité de cablage sur mesure

*1 Module Secours

*2 Filtre vert sur demande

Fitting in thermoplast E27

Soquet thermoplastique E27

BESTELNUMMER N° DE COMMANDE	Kleur	Couleur	VERP. EMB.
755	Zwart	Noir	50 / 500
755W	Wit	Blanc	50 / 500



Kit HALO+SOCKET

Kit HALO+SOCKET

BESTELNUMMER N° DE COMMANDE	Vermogen Puissance	VERP. EMB.
PROMOKITHALO	57W	1

50 x Soquet E27 rapide noir
 50 x ampoule halogène 57W
 50 x zwarte E27 lampenvoet
 50 x Halogeen gloeilamp 57W



Kit LED+SOCKET

Kit LED+SOCKET

BESTELNUMMER N° DE COMMANDE	VERP. EMB.
PROMOKITLED	1

50 x Soquet E27 rapide noir
 50 x ampoule LED non dimmable 10W/2700K/806lm
 50 x zwarte E27 lampenvoet
 50 x niet dimbare LED lamp 10W/2700K/806lm
 Automatische draadklem Thermoplastisch Zonder deksel Automatische bevestiging van deksel
 Connexions automatiques THERMOPLASTIQUE Sans couvercle Fixation automatique du couvercle



EURO COMPLETA

EURO COMPLETA

BESTELNUMMER N° DE COMMANDE	Spécificité Specificiteit	Afmetingen dimensions	Stroomsterkte Ampérage	Flux Nom. Nom. Stroom	VERP. EMB.
B4114	SE/SA - IP42	300 x 138 x 55 mm	LiFe 3,2V 1,5Ah	200 - 70	1
B4116	SE/SA - IP65	300 x 138 x 55 mm	LiFe 3,2V 1,5Ah	200 - 70	1
B4113	SE/SA - IP42	300 x 138 x 55 mm	LiFe 3,2V 0,5Ah	120 - 40	1
B4115	SE/SA - IP65	300 x 138 x 55 mm	LiFe 3,2V 0,5Ah	120 - 40	1



Noodverlichting met een innovatief optisch systeem die een goede verspreiding van de lichtstraal garandeert
Groot functioneel kabelcompartiment geschikt voor 2,5 mm geleiders en bestemd voor doorvoerbekabeling
Beschikbaar in IP42 en IP65 voor muur-, plafond- en inbouwinstallatie
Geschikt voor installatie met buizen van Ø16 en Ø20

SE = niet permanente verlichting

SA = permanente verlichting

Normen : EN 60598-1, EN 60598-2-2, EN 60598-2-22, EN 1838, UNI 11222-

Werkings temperatuur : 0 - 50°C

Autonomie : 1 h/u

Dispositif d'éclairage de secours avec un système optique innovant qui offre une bonne répartition du faisceau lumineux

Grand compartiment de câblage fonctionnel pour accueillir des conducteurs de 2,5 mm et prédisposé pour le câblage traversant

Disponible en IP42 et IP65 installation murale et au plafond et encastré

Préparé pour l'installation avec des tubes Ø16 et Ø20

SE = éclairage non permanent

SA = éclairage permanent

Normes : EN 60598-1, EN 60598-2-2, EN 60598-2-22, EN 1838, UNI 11222

Température de fonctionnement : 0 - 50°C



AESTETICA LED

AESTETICA LED

BESTELNUMMER N° DE COMMANDE	Afmetingen dimensions	Vermogen Puissance	Nbr. LED Aantal LED	Flux Nom. Nom. Stroom
B16221	292 x 102 x 34,6 mm	8 W - SE	16	130 lm
B16222	292 x 102 x 34,6 mm	11 W - SE	20	160 lm



Rechthoekig compact noodverlichtingstoestel

Met hoog rendement led

Geschikt voor muur, plafondmontage en eventueel rechtstreeks op modulaire inbouwdozen

Materiaal: zelfdovende kunststof

Volgens normen EN 60598-1, UL 94

Groene led aanduiding voor netaanwezigheid

Voeding: 230 V

Beschermingsgraad: IP40

Electrische isolatie: II

Oplaadtijd: 12 uur

SE niet permanente verlichting

SA permanente verlichting

Eclairage de secours rectangulaire

Avec led à haute efficacité

Prévu pour mur, plafond et éventuellement directement sur boîtiers muraux modulaires

Matière: plastique autoextinguible

Selon normes EN 60598-1, UL 94

Indicateur led verte pour la présence réseau

Alimentation: 230 V

Indice de protection: IP40

Isolation électrique: II

Temps de charge: 12 h

SE = éclairage non permanent

SA = éclairage permanent



AESTETICA LED

AESTETICA LED

BESTELNUMMER N° DE COMMANDE	Afmetingen dimensions	Vermogen Puissance	Nbr. LED Aantal LED	Flux Nom. Nom. Stroom
B16223	292 x 102 x 34,6 mm	11 W - SA	20	160 lm
B16224	292 x 102 x 34,6 mm	24 W - SE	32	224 lm
B16226	292 x 102 x 34,6 mm	24 W - SA	32	224 lm



Rechthoekig compact noodverlichtingstoestel
 Met hoog rendement led
 Geschikt voor muur, plafondmontage en eventueel rechtstreeks op modulaire inbouwdozen
 Materiaal: zelfdovende kunststof
 Volgens normen EN 605981, UL 94
 Groene led aanduiding voor netaanwezigheid
 Voeding: 230 V
 Beschermingsgraad: IP40
 Electriche isolatie: II
 Opladttijd: 12 uur
 SE niet permanente verlichting
 SA permanente verlichting
 Eclairage de secours rectangulaire
 Avec led à haute efficacité
 Prévu pour mur, plafond et éventuellement directement sur boîtiers muraux modulaires
 Matière: plastique autoextinguible
 Selon normes EN 60598-1, UL 94
 Indicateur led verte pour la présence réseau
 Alimentation: 230 V
 Indice de protection: IP40
 Isolation électrique: II
 Temps de charge: 12 h
 SE = éclairage non permanent
 SA = éclairage permanent



Pratica 250 LED

Pratica 250 LED

BESTELNUMMER N° DE COMMANDE	Omschr.	Descr.	Afmetingen dimensions	Spanning tension	Vermogen Puissance	VERP. EMB.
B250ATSE	NIET PERMANENT	NON PERMANENT	300 x 138 x 55 mm	230V	24W	1
B250ATSA	PERMANENT	PERMANENT	300 x 138 x 55 mm	230V	24W	1



NOODVERLICHTING - PRATICA 250LM
 ÉCLAIRAGE DE SECOURS - PRATICA 250LM
 Equivalent power* 24 W
 Power supply 230Vac ± 10% 50Hz
 Version Maintained (SA), Non-maintained (SE),
 Rest Mode
 Standard EN 60598-1, EN 60598-2-2,
 EN 60598-2-22, EN 1838,
 UNI 11222
 Protection grade IP65, IK08
 Autonomy 1,5h, 3h
 Charging time 12 h
 Working temp. -10°C ÷ +60°C
 Control gear Electronic driver
 Body White polycarbonate RAL 9003
 Optics Anti-glare
 Difusser Transparent polycarbonate
 Light source LED 5000K



INFINITA RTI IP65SE CBL LTO XL

INFINITA RTI IP65SE CBL LTO XL

BESTELNUMMER N° DE COMMANDE	Vermogen Puissance	Flux Nom. Nom. Stroom	VERP. EMB.
B19451	24W	500/340/ 260/180/70 lm4000K	1

Led noodverlichting
 10 jaar garantie (titaniumbatterij)
 RTI IP65 SE CBL LTO XL IK08
 Eclairage de secours led
 Garantie 10 ans (Titanium Battery)



Geïsoleerde kamgeleider VORK

Peigne isolé FOURCHE

BESTELNUMMER N° DE COMMANDE	∅	Modules	Fase Phase	VERP. EMB.
IZ10/2F/54	10mm	54	L1,L2/N	20
IZ16/2F/54	16mm	54	L1,L2/N	10
IZ10/3F/54	10mm	54	L1,L2,L3	20
IZ16/3F/54	16mm	54	L1,L2,L3	20
IZ16/4F/56	16mm	56	L1,L2,L3,N	10
IZ16/4FN/54	16mm	54	L1 N L2 N L3 N	10

L 1m

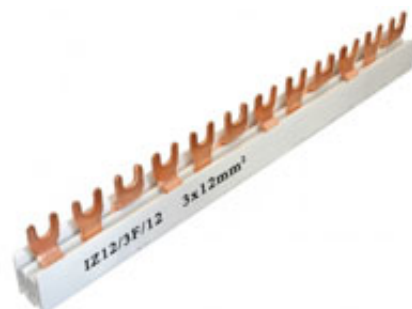

Geïsoleerde kamgeleider PIN

Peigne isolé BROCHE

BESTELNUMMER N° DE COMMANDE	∅	Modules	Fase Phase	VERP. EMB.
IZS10/3F/54	10mm	54	L1,L2,L3	20
IZS16/3F/54	16mm	54	L1,L2,L3	20
IZS16/2F/54	16mm	54	L1,L2/N	10
IZS16/4F/56	16mm	56	L1,L2,L3,N	10

L 1m

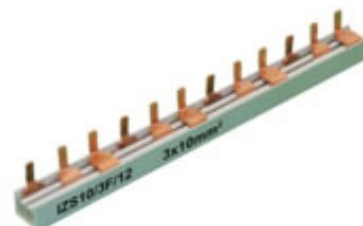

Eindstuk

Embout

BESTELNUMMER N° DE COMMANDE	Spécificité Specificiteit	∅	Polen Poles	VERP. EMB.
Z102F	IZ10/2F/54	10 mm ²	3	10/250
Z103F	IZ10/3F/54	10 mm ²	3	10/250
Z162F	IZ16/2F/54	16 mm ²	2	10/250
Z163F	IZ16/3F/54	16 mm ²	3	10/250
Z164F	IZ16/4F(N)/56	16 mm ²	4	10/250
ZS102F	IZS10/2F/54	10 mm ²	3	10/250
ZS103F	IZS10/3F/54	10 mm ²	3	10/250
ZS162F	IZS16/2F/54	16 mm ²	2	10/250
ZS163F	IZS16/3F/54	16 mm ²	3	10/250
ZS164F	IZS16/4F/56	16 mm ²	4	10/250



Niet geïsoleerde kabelschoenen Geleidbaarheid / Conductiv

Souliers de câbles non isolés

BESTELNUMMER N° DE COMMANDE	∅	Temp.couleur Kleur Temp.
D006/05	5,2 mm	1
D006/06	6,5 mm	1
D006/08	8,4 mm	1
D010/05	5,2 mm	1
D010/06	6,5 mm	1
D010/08	8,4 mm	1
D010/10	10,5 mm	1
D016/05	5,2 mm	1
D016/06	6,5 mm	1
D016/08	8,4 mm	1
D016/10	10,5 mm	1
D025/06	6,5 mm	1
D025/08	8,4 mm	1
D025/10	10,5 mm	1
D035/06	6,5 mm	1
D035/08	8,4 mm	1
D035/10	10,5 mm	1
D035/12	13 mm	1
D050/06	6,5 mm	1
D050/08	8,4 mm	1
D050/10	10,5 mm	1
D050/12	13 mm	1
D070/08	8,4 mm	1
D070/10	10,5 mm	1
D070/12	13 mm	1
D070/14	15 mm	1
D095/08	8,4 mm	1
D095/10	10,5 mm	1
D095/12	13 mm	1
D095/14	15 mm	1
D120/10	10,5 mm	1
D120/12	13 mm	1
D120/14	15 mm	1
D150/08	8,4 mm	1
D150/10	10,5 mm	1
D150/12	13 mm	1



Vertind / Etamé

Geleidbaarheid / Conductivité : 99,9 % IACS BS 6017 - BS 1977

Afmeting in mm² van de kabel : het getal van het bestelnummer voor de / : bv. D035/10. Dimension en mm² du câble : le nombre du n° de commande avant le / : p.e. D035/10.

OPMERKING :

Wanneer soepele kabels gebruikt worden, is het noodzakelijk de volgende kabelschoen te selecteren.

REMARQUE :

Quand un câble souple est utilisé, il est nécessaire de sélectionner la dimension suivante plus grande.

Niet geïsoleerde kabelschoenen Geleidbaarheid / Conductiv

Souliers de câbles non isolés

BESTELNUMMER N° DE COMMANDE	∅	Temp.couleur Kleur Temp.
D150/14	15 mm	1
D185/10	10,5 mm	1
D185/12	13 mm	1
D185/14	15 mm	1
D240/12	13 mm	1
D240/14	15 mm	1
D240/20	20 mm	

Vertind / Etamé

Geleidbaarheid / Conductivité : 99,9 % IACS BS 6017 - BS 1977

Afmeting in mm² van de kabel : het getal van het bestelnummer voor de / : bv. D035/10. Dimension en mm² du câble : le nombre du n° de commande avant le / : p.e. D035/10.

OPMERKING :

Wanneer soepele kabels gebruikt worden, is het noodzakelijk de volgende kabelschoenen te selecteren.

REMARQUE :

Quand un câble souple est utilisé, il est nécessaire de sélectionner la dimension suivante plus grande.



Doorverbinders

Raccords

BESTELNUMMER N° DE COMMANDE	Afmetingen dimensions	∅ IN	Temp.couleur Kleur Temp.
DB06	06 mm ²	∅ 3,8 mm	
DB10	10 mm ²	∅ 4,5 mm	1
DB16	16 mm ²	∅ 5,4 mm	1
DB25	25 mm ²	∅ 6,8 mm	1
DB35	35 mm ²	∅ 8,2 mm	1
DB50	50 mm ²	∅ 9,5 mm	1
DB70	70 mm ²	∅ 11,2 mm	1
DB95	95 mm ²	∅ 13,5 mm	1
DB120	120 mm ²	∅ 15 mm	1
DB150	150 mm ²	∅ 16,5 mm	1
DB185	185 mm ²	∅ 18,5 mm	1
DB240	240 mm ²	∅ 21 mm	1

Afmeting in mm² van de kabel :

- 2,5 mm² voor DB02
- het getal na DB.. in het bestelnummer

Dimensions en mm² du câble :

- 2,5 mm² pour DB02
- le nombre après DB.. dans le n° de commande



Geïsoleerde kabelschoenen 0,5 à 1,5 mm²

Souliers de câbles isolés 0,5 à 1,5 mm²



De geïsoleerde kabelschoenen zijn in koper en messing met hoge conductiviteit, vertind voor een verhoogde weerstand tegen corrosie. Les cosses préisolées sont en cuivre et laiton de haute conductivité, étamés pour résistance à la corrossion.

Verpakking / emballage : 100 / 1000

BESTELNUMMER N° DE COMMANDE	Omschr.	Descr.	ø	Temp.cou Kleur Temp.
DVR1/03	Ring	Ring	3,2	1
DVR1/03.7	Ring	Ring	3,7	1
DVR1/04	Ring	Ring	4,3	1
DVR1/05	Ring	Ring	5,3	1
DVR1/06	Ring	Ring	6,4	1
DVR1/08	Ring	Ring	8,4	1
DVR1/10	Ring	Ring	10,5	1
DVR1/12	Ring	Ring	13	1
DVF1/03	Vork	Fourchett	3,2	1
DVF1/03.7	Vork	Fourchett	3,7	
DVF1/04	Vork	Fourchett	4,3	1
DVF1/05	Vork	Fourchett	5,3	1
DVF1/06	Vork	Fourchett	6,4	1
DVPO1/4.8M	Doorverb. Mannelijk	Raccord mâle	-	1
DVPO1/6.3M	Doorverb. Mannelijk	Raccord mâle	-	1
DVPO1/2.8F	Doorverb. vrouwelijk	Raccord fémelle		1
DVPO1/4.8F	Doorverb. vrouwelijk	Raccord fémelle		
DVPO1/6.3F	Doorverb. vrouwelijk	Raccord fémelle		1
DVFP01/4.8F	Vrouwelijk geheel geïsoleerc	Fémelle complète isolé		
DVFP01/6.3F	Vrouwelijk geheel geïsoleerc	Fémelle complète isolé		1
DVFP01/2.8F	Vrouwelijk geheel geïsoleerc	Fémelle complète isolé		
DVPOA1/6.3	Mannelijk + vrouwelijk	Mâle + fémelle		1
DVAB1M	Rond mannelijk	Mâle rond		1
DVAB1F	Rond vrouwelijk	Fémelle rond		1
DVBC1	Doorverb.	Raccord		1
DVP1/09	Pin	Embout	9	1
DVP1/12	Pin	Embout	12	1

Geïsoleerde kabelschoenen 1,5 à 2,5 mm²

Souliers de câbles isolés 1,5 à 2,5 mm²



BESTELNUMMER N° DE COMMANDE	Omschr.	Descr.	ø	Temp.cou Kleur Temp.
DVR2/03	Ring	Plage oeil	3,2 mm	1
DVR2/03.7	Ring	Plage oeil	3,7 mm	1
DVR2/04	Ring	Plage oeil	4,3 mm	1
DVR2/05	Ring	Plage oeil	5,3 mm	1
DVR2/06	Ring	Plage oeil	6,4 mm	1
DVR2/08	Ring	Plage oeil	8,4 mm	1
DVR2/10	Ring	Plage oeil	10,5 mm	1
DVR2/12	Ring	Plage oeil	13 mm	1
DVF2/03	Vork	Fourchett	3,2 mm	1
DVF2/03.7	Vork	Fourchett	3,7 mm	
DVF2/04	Vork	Fourchett	4,3 mm	1
DVF2/05	Vork	Fourchett	5,3 mm	1
DVF2/06	Vork	Fourchett	6,4 mm	1
DVPO2/6.3M	Doorverb. mannelijk	Raccord mâle		1
DVPO2/2.8F	Doorverb. vrouwelijk	Raccord fémelle		1
DVPO2/6.3F	Doorverb. vrouwelijk	Raccord fémelle		1
DVFO2/4.8F	Vrouwelijk geheel geïsoleerc	Fémelle compl. isolé		
DVFO2/6.3F	Vrouwelijk geheel geïsoleerc	Fémelle compl. isolé		1
DVPOA2/6.3	Mannelijk + vrouwelijk	Mâle + fémelle		1
DVAB2M	Rond mannelijk	Mâle rond		1
DVAB2F	Rond vrouwelijk	Fémelle rond		1
DVBC2	Doorverb.	Raccord		1
DVP2/09	Pin	Embout	9	1
DVP2/12	Pin	Embout	12	1

De geïsoleerde kabelschoenen zijn in koper en messing met hoge conductiviteit, vertind voor een verhoogde weerstand tegen corrosie.

Les cosses préisolées sont en cuivre et laiton de haute conductivité, étamés pour résistance à la corrosion.

Geïsoleerde kabelschoenen 4 à 6 mm²

Souliers de câbles isolés 4 à 6 mm²



BESTELNUMMER N° DE COMMANDE	Omschr.	Descr.	ø	Temp.cou Kleur Temp.
DVR5/04	Ring	Plage oeil	4,3 mm	1
DVR5/05	Ring	Plage oeil	5,3 mm	1
DVR5/06	Ring	Plage oeil	6,4 mm	1
DVR5/08	Ring	Plage oeil	8,4 mm	1
DVR5/10	Ring	Plage oeil	10,5 mm	1
DVR5/12	Ring	Plage oeil	13 mm	1
DVF5/ 03	Vork	Fourchett	3,7 mm	
DVF5/ 04	Vork	Fourchett	4,3 mm	
DVF5/05	Vork	Fourchett	5,3 mm	1
DVF5/06	Vork	Fourchett	6,4 mm	1
DVF5/08	Vork	Fourchett	8 mm	1
DVP O 5 /6 .3 M	Doorverb. mannelijk	Raccord mâle		
DVP O 5 /6 .3 F	Doorverb. vrouwelijk	Raccord fémelle		
DVP O 5 /9 .5 F	Doorverb. vrouwelijk	Raccord fémelle		
DVFP O5 /6.3F	Vrouwelijk geheel geïsoleerc	Fémelle complète isolé		
DVFP O5 /9.5F	Vrouwelijk geheel geïsoleerc	Fémelle complète isolé		
DVBC 5	Doorverb.	Raccord		
DVP 5/ 1 4	Pin	Embout	14	

De geïsoleerde kabelschoenen zijn in koper en messing met hoge conductiviteit, vertind voor een verhoogde weerstand tegen corrosie.

Les cosses préisolées sont en cuivre et laiton de haute conductivité, étamés pour résistance à la corrsosion.

Clips

Clips

BESTELNUMMER N° DE COMMANDE	Oud ref. Ancienne réf	profil	Opmerking	VERP. EMB.
FH4-DT	SI100DT	1,5 - 4 mm	1001300150	100
FH10-DT	SI101DT	4 - 10 mm	1001300250	100
FH15-DT	SI102DT	10 - 15 mm	1001300350	100
FH20-DT	SI103DT	15 - 20 mm	1001300450	100



Voor draadstang

Pour Tige filetée

BESTELNUMMER N° DE COMMANDE	Oud ref. Ancienne réf	profil	Opmerking	VERP. EMB.
FH20-ICA10DT	SI103-212DT	15 - 20 mm / M10	1001309650	100
FH15-ICA10DT	SI102-212DT	10 - 15 mm / M10	1001308150	100
FH4-ICA8DT	SI100-211DT	1,5 - 4 mm / M8	1001305050	100
FH15-ICA8DT	SI102-211DT	10 - 15 mm / M8	1001308050	100
FH20-ICA6DT	SI103-210DT	15 - 20 mm / M6	1001309450	100
FH20-ICA8DT	SI103-211DT	15 - 20 mm / M8	1001309550	100
FH10-ICA8DT	SI101-211DT	4 - 10 mm / M8	1001306550	100
FH10-ICA6DT	SI101-210DT	4 - 10 mm / M6	1001306450	100
FH15-ICA6DT	SI102-210DT	10 - 15 mm / M6	1001307950	100
FH4-ICA6DT	SI100-210DT	1,5 - 4 mm / M6	1001304950	100
FH4-ICA10DT	SI100-212DT	1,5 - 4 mm / M10	1001305150	100
FH10-ICA10DT	SI101-212DT	4 - 10 mm / M10	1001306650	100



Voor kabelbinder

Pour Collier de Câblage

BESTELNUMMER N° DE COMMANDE	Oud ref. Ancienne réf	profil	Opmerking	VERP. EMB.
FH20-BRDT	SI103-250DT	15 - 20 mm	Code : 1001317450	100
FH15-BRDT	SI102-250DT	10 - 15 mm	Code : 1001317350	100
FH10-BRDT	SI101-250DT	4 - 10 mm	Code : 1001317250	100
FH4-BRDT	SI100-250DT	1,5 - 4 mm	Code : 1001317150	100



Klem - M6x9

Attache - M6x9

BESTELNUMMER N° DE COMMANDE	Oud ref. Ancienne réf	profil	Opmerking	VERP. EMB.
FU7TM6DT	SI104TM6DT	3 - 7 mm	1001300650	100
FU12-5TM6DT	SI105TM6DT	7 - 13 mm	1001300850	100
FU20TM6DT	SI106TM6DT	14 - 20 mm	1001301050	100



Klem - M8x14

Attache - M8x14

BESTELNUMMER N° DE COMMANDE	Oud ref. Ancienne réf	profil	Opmerking	VERP. EMB.
FU7TM8DT	SI104TM8DT	3 - 7 mm	1001320650	100
FU12-5TM8DT	SI105TM8DT	7 - 13 mm	1001320850	100
FU20TM8DT	SI106TM8DT	14 - 20 mm	1001321050	100
FU7DT	SI104DT	3 - 7 mm	1001300550	100
FU12-5DT	SI105DT	7 - 13 mm	1001300750	100
FU20DT	SI106DT	14 - 20 mm	1001300950	100



Klem

Attache

BESTELNUMMER N° DE COMMANDE	Oud ref. Ancienne réf	profil	Opmerking	VERP. EMB.
SB17-11DT	SI130DT	max. 16 mm	1001365050	100

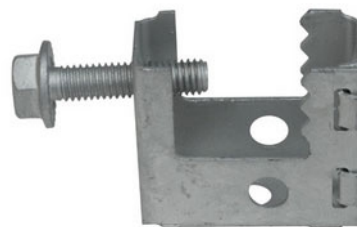

CLIPS

CLIPS

BESTELNUMMER N° DE COMMANDE	Oud ref. Ancienne réf	ø	profil	Opmerking	VERP. EMB.
CD4-9DT	SI306DT	8 - 9 mm	1 - 4 mm	1001302750	100
CD7-5-9DT	SI307DT	8 - 9 mm	4 - 7,5 mm	1001302850	100
CD12-9DT	SI307.2DT	8 - 9 mm	7,5 - 12 mm	1001325850	100
CD4-11DT	SI308DT	10 - 11 mm	1 - 4 mm	1001302950	100
CD7-5-11DT	SI309DT	10 - 11 mm	4 - 7,5 mm	1001303050	100
CD12-11DT	SI309.2DT	10 - 11 mm	7,5 - 12 mm	1001325950	100
CD4-14DT	SI310DT	12 - 14 mm	1 - 4 mm	1001303150	100
CD7-5-14DT	SI311DT	12 - 14 mm	4 - 7,5 mm	1001303350	100
CD12-14DT	SI311.2DT	12 - 14 mm	7,5 - 12 mm	1001326050	100
CD4-18DT	SI312DT	15 - 18 mm	1 - 4 mm	1001303450	100
CD7-5-18DT	SI313DT	15 - 18 mm	4 - 7,5 mm	1001303650	100
CD12-18DT	SI313.2DT	15 - 18 mm	7,5 - 12 mm	1001326150	100
CD4-24DT	SI314DT	19 - 24 mm	1 - 4 mm	1001303750	100
CD7-5-24DT	SI315DT	19 - 24 mm	4 - 7,5 mm	1001303950	100
CD12-24DT	SI315.2DT	19 - 24 mm	7,5 - 12 mm	1001326250	100
CD4-30DT	SI316DT	25 - 30 mm	1 - 4 mm	1001304050	100



CLIPS

CLIPS

BESTELNUMMER N° DE COMMANDE	Oud ref. Ancienne réf	ø	profil	Opmerking	VERP. EMB.
CD7-5-30DT	SI317DT	25 - 30 mm	4 - 7,5 mm	1001304250	100
CD12-30DT	SI317.2DT	25 - 30 mm	7,5 - 12 mm	1001326350	100



Hand Protective Foam

Mousse de protection pour main

BESTELNUMMER N° DE COMMANDE	CONTENU INHOUD	VERP. EMB.
W11850200	200 ml	1

Data sheets and certificate on www.gsv.be



Hydroalcoholische handgel 72%

Gel pour mains hydroalcolique 72%

BESTELNUMMER N° DE COMMANDE	Afmetingen dimensions	CONTENU INHOUD	VERP. EMB.
VS120E	290 x 195 x 120	120ml	1/24
VS250E	210 x 160 x 185	250ml	1/12
VS500E	245 x 165 x 170	500ml	1/6
VS03XLDE	380 x 300 x 200	3L*1	1/4
VS05XLE	280 x 200 x 295	5L*2	1/2

*1 Met pomp / avec pompe

*2 Voor navulling / recharge

(EC) No 1272/2008

Ready-to-use

Varwacht / Attendu le 01/07/2020

NIEUW
NOUVEAU
REF.



GEL - Eén component - Cartridge

GEL - Mono composant - Cartouche

BESTELNUMMER N° DE COMMANDE	CONTENU INHOUD
MPONE GEL	300 ml (Injecteerbaar / Injectable)



Gel – twee componenten

Gel – bi composant

BESTELNUMMER N° DE COMMANDE	CONTENU INHOUD
MP0030	300 ml
MP0100	1 L (2 X 0,5 L.)
MP1000	10 L
MP2200	2 L

info 123 NL
info 123



Polyurethaan hars – twee componenten

Résine polyuréthane – Bi composant

BESTELNUMMER N° DE COMMANDE	CONTENU INHOUD
RS150	0,110 L
RS300	0,220 L
RS400	0,290 L
RS550	0,400 L
RS650	0,470 L
RS1650	1,200 L

Met veiligheids vulsysteem
Avec système de remplissage



SHARK - Rechte koppelingen gevuld met gel - met connector

SHARK - Joints pré-remplis en gel - avec connexion

BESTELNUMMER N° DE COMMANDE	Afmetingen dimensions	∅	Polen Poles
SHARK150	86x47 mm	*	1
SHARK325	86x47 mm	1,5 - 2,5 mm ²	3
SHARK306	145x50 mm	1,5 - 6 mm ²	3
SHARK516	180x69 mm	6 - 16 mm ²	5
SHARK506	146x50 mm	1,5 - 6 mm ²	5

*6 à 25 mm² : voor harde draad
 35mm² : voor flexibele draad
 *6 à 25 mm² : pour câble rigide
 35mm² : pour câble souple



Y Koppeling gevuld met Gel Met Connector

Joint en Y pré-rempli en Gel avec Connexion

BESTELNUMMER N° DE COMMANDE	Afmetingen dimensions	∅	Polen Poles
SHARK516Y	220 x 110 mm	6 - 16 mm ²	5

*6 - 16 mm²



SHARK - Rechte koppelingen gevuld met gel

SHARK - Joints pré-remplis en gel

BESTELNUMMER N° DE COMMANDE	Afmetingen dimensions	∅	Polen Poles
SHARK506WS	180x69 mm	6 - 16 mm ²	5
SHARK525WS	240x75 mm	6 - 25 mm ²	5

Met connector & trekcontlasting
 Avec connexion & serre-câble



SHARK68 - Rechte koppelingen IP68

SHARK68 - Joints IP68

BESTELNUMMER N° DE COMMANDE	∅	Polen Poles
SHARK6801A	6 - 50 mm ²	1
SHARK6801B	1,5 - 6 mm ²	3
SHARK6801C	1,5 - 6 mm ²	3
SHARK6801D	2,5 - 6 mm ²	4
SHARK6802A	2,5 - 10 mm ²	5
SHARK6803A	10 - 25 mm ²	5

IP 68



Koppeling gevuld met Gel - IP68 - Voor Tuinspot

Jonction IP68 pré-remplie de Gel pour Spot Led encastrable

BESTELNUMMER N° DE COMMANDE	Afmetingen dimensions	∅	VERP. EMB.
LDJ01	118x25 mm	0,5 - 1,5 mm ²	1

IP68, 450V, 24A; EN60529



LEJOY
SMART CONNECTION

Met gel gevulde Mini Box

pré-rempli de gel

BESTELNUMMER N° DE COMMANDE	Afmetingen dimensions	∅	VERP. EMB.
MJB112	33x26x2 mm	0,2 - 4 mm ²	2/12
MJB113	33x26x2 mm	0,2 - 4 mm ²	2/12
MJB215	33x34x23 mm	0,2 - 4 mm ²	1/12
MJB222	33x34x23 mm	0,2 - 4 mm ²	1/12
MJB332	33x46x23 mm	0,2 - 4 mm ²	1/12



Siliconen

Silicone

BESTELNUMMER N° DE COMMANDE	Afmetingen dimensions	Kleur	Couleur	VERP. EMB.
PARASILICO VP TRANS	310ml	TRANSPARANT	TRANSPARANT	1 / 25
SILAM85-1 TRANSPARANT	310ml	TRANSPARANT	TRANSPARANT	1 / 25
SILAM85-1 WHT	310ml	WIT	BLANC	1 / 25
SILAM85-1 BLK	310ml	ZWART	NOIR	1 / 25
SILSANITAIR	310ml	TRANSPARANT		1 / 25

MEER KLEUREN OP BESTELLING
PLUS DE COULEURS SUR COMMANDE



Lijm

Colle

BESTELNUMMER N° DE COMMANDE	Afmetingen dimensions	Kleur	Couleur	VERP. EMB.
PARABOND 600 GRY	290ml	GRIJS	GRIS	1 / 25
PARABOND 600 WHT	290ml	WIT	BLANC	1 / 25
PARABOND 600 BLK	290ml	ZWART	NOIR	1 / 25
PARABOND 700 WHT	290ml	WIT	BLANC	1 / 25
PARABOND 700 BLK	290ml	ZWART	NOIR	1 / 25
PARABOND 800 WHT	290ml	WIT	BLANC	1 / 12
PARABOND 800 BLK	290ml	ZWART	NOIR	1 / 12
PARACOL PU D4 RAPID	310ml			1 / 25

MEER KLEUREN OP BESTELLING
PLUS DE COULEURS SUR COMMANDE



Polyurethaanschuim

Mousse PU

BESTELNUMMER N° DE COMMANDE	Afmetingen dimensions	VERP. EMB.
PARAFOAM FIRE NBS	750ml	1 / 12
PARAFOAM NBS	750ml	1 / 12
PARAFOAM REMOVER	500ml	
PARAFOAM.GUN & SPRAY CL.	500ml	



Vorstwerend Snoer

Cable anti-gel

BESTELNUMMER N° DE COMMANDE	Afmetingen dimensions	ø	VERP. EMB.
EASY02	2 m	0,2 - 4 mm ²	1
EASY04	4 m	0,2 - 4 mm ²	1
EASY08	6 m	0,2 - 4 mm ²	1
EASY12	12 m	0,2 - 4 mm ²	1
EASY18	18 m	0,2 - 4 mm ²	1

Incl. Thermost. IPX7, 230V



ZELFREGULERENDE VERWARMINGSKABEL

CÂBLE CHAUFFANT AUTO REGULANT

BESTELNUMMER N° DE COMMANDE	Spécificité Specificiteit	Afmetingen dimensions	ø	Spaning tension	VERP. EMB.
HTC18S	-20°C > +10°C	8 x 5 mm	0,55 mm ²	230 V AC	1



ISOLERENDE BUIS UITLAAT KIT

KIT POUR SORTIE TUBE ISOLANT

BESTELNUMMER N° DE COMMANDE	Spécificité Specificiteit	VERP. EMB.
KCP00S	Series S	1

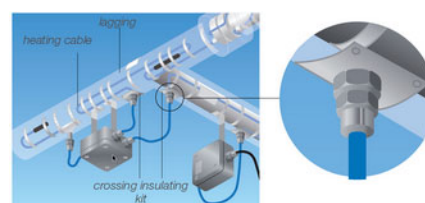

KIT CONNECTIE EN EINDSTUK

KIT CONNECTION ET EMBOUT

BESTELNUMMER N° DE COMMANDE	Spécificité	VERP. EMB.
KTA00S	Series S	1

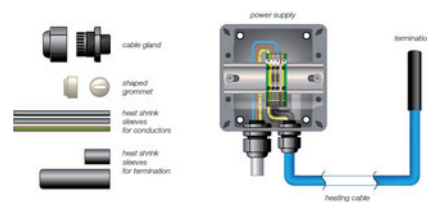

PGBZ60090V 89
PGBZ60090V 89

0

010TARM016 86
010TARM020 86
010TARM025 86
010TARM032 86
010TARM040 86
010TARM050 86
010TARM063 86
020CARM016 86
020CARM020 86
020CARM025 86
020CARM032 86
020CARM040 86
020CARM050 86
020CARM063 86
020MARM016 87
020MARM020 87
020MARM025 87
020MARM032 87
020MARM040 87
020MARM050 87
020MARM063 87
031G 99, 100
031T 99, 100
060TARMi20 86
060TARMi25 86
060TARMi32 86
060TARMi40 86
060TARMi50 86
061CARMi20 87
061CARMi25 87
061CARMi32 87
061CARMi40 87
061CARMi50 87
061MACMI20 87
061MACMI32 87
061MACMI40 87
061MACMI50 87
061MARMi25 87

1

10012 54
108 98
11405 131
11410 131
11415 131
11420 131
11425 131
11430 131
11605 131
11610 131
11615 131
11620 131
11625 131
11630 131

2

2035 98
2036 98
2036 Black ... 83

2

2036 D 100
2037 98
2037 Black ... 83
2037 D 100
2038 98
2039 98
204 98
204 Black 83
204 D 100
204 White 83
20436 99
2047 102
2048 102
2050 103
2051 103
208 98
208 Black 83
209 98
20BLI 27
210 98
211 98
211 D 100
219B 62
220A 61
220AM 61
220B 62
222A 61
222AM 61
222B 62
223A 61
223AM 61
223ATA 61
223ATAM 61
223B 62
223BTA 62
223LTATR 65
224A 61
224AM 61
224B 62
224LTR 65
226B 62
242-MFM2 ... 64
242MFTR 64
250001 56
250002 56
250005 56
250-11AM 71
250-5AM 71
250-9AM 71
250-9B 71
251001 56
251001C 56
251002 56
251002C 56
273MF 69
28.41 65
28.43 66
28.43-PLEXI . 66
28.51 65
28.53 66
28.61 65

2

28.998 66
28.999 66
28481 108
28483 108

3

3004/18 48
3005/18 48
3006/18 48
300620W 50
3007/18 48
3007-18Black 83
300720W 50
3008/20 48
3009/20 48
3010/35 48
3011/35 48
3012/35 48
3014/40 48
3016/40 48
3018/40 48
3020/40 48
305505 131
305510 131
305515 131
305520 131
305525 131
305530 131
310816 133
310820 133
310825 133
311616 133
311620 133
311625 133
316 75
318 75
350001 57
350002 57
36.81 68
37000 132
37010 132
37020 132
37030 132
37040 132
37050 132
37060 132
37070 132
37080 132
37090 132
37100 132
37110 132
37120 132
37130 132
37140 132
37150 132
37160 132
37170 132
397-3A 39
397-5 39
398-5 39
399-5 39

4

411620 50
41E 27
41G 28
41I 27
41L 27
41S 28
41T 28
424 73
426 73
428 73
429 73
430 74
430V 75
431 74
431V 75
44E 27
44G 28
44L 27
44T 28
4570 60
460 150
470 150
471 150

5

501018 54
501025 54
501030 54
501040 54
50612M 97
50616M 97
50620M 97
50625M 97
50632M 97
50640M 97
50650M 97
50663M 97
50704 38
50706 38
50710 38
50716 38
50725 38
512 101
512/2 101
513 101
513/2 101
515 101
515/2 101
516 101
516/2 101
517 101
517/2 101
518 101
518/2 101
519 101
520 101
5605-16 108
5605-22 108
5605-28 108
5605-38 108
5605-50 108
5605-60 108

5

5720 59
 5721 59
 5722 59
 5725 59
 5726 59
 5727 59

6

601620 50
 601922 50
 602125 50
 611620 50
 611922 50
 612125 50
 679316/1 119
 679316/2 118
 679316/3 118
 679316/4 118
 679332/1 119
 679332/2 118
 679332/3 118
 679332/4 118
 679363/5 119
 679363/6 118
 679363/7 118
 679363/8 118
 679416/1 119
 679416/2 118
 679416/3 118
 679416/4 118
 679432/1 119
 679432/2 118
 679432/3 118
 679432/4 118
 679463/5 119
 679463/6 118
 679463/7 118
 679463/8 118
 679516/1 119
 679516/2 118
 679516/3 118
 679516/4 118
 679532/1 119
 679532/2 119
 679532/3 118
 679532/4 118
 679563/5 119
 679563/6 119
 679563/7 118
 679563/8 118

7

700/02 48
 700/05 48
 700/08 48
 700/11 48
 700/16 48
 700/23 48
 700-08 Black 48
 701516 103
 701920 103
 702/0 49

7

702/1 49
 702/2 49
 702/3 49
 702225 103
 703235 103
 7520001 74
 7520002 74
 755 151
 755W 151

9

905 102
 90507 95
 90509 95
 90511 95
 90513 95
 90516 95
 90521 95
 90529 95
 90536 95
 90548 95
 905M12 91
 905M16 91
 905M20 91
 905M25 91
 906 102
 906/2 102
 90607 96
 90609 96
 90611 96
 90613 96
 90616 96
 90621 96
 90629 96
 90636 96
 90648 96
 907 102
 90707 96
 90709 96
 90711 96
 90713 96
 90716 96
 90721 96
 90729 96
 90736 96
 90748 96
 907M12 92
 907M16 92
 907M20 92
 907M20 Black 81
 907M25 92
 907M32 92
 907M40 92
 907M50 92
 907M63 92
 908 102
 908M16 93
 908M20 93
 908M25 93
 908M32 93
 908M40 93
 908M50 93

9

909M16 93
 909M20 93
 90HS4 55
 90HSM6 55
 90HSXXX 55
 91000/01 104
 91000/02 104
 91000/04 104
 91000/05 104
 91000/07 104
 91000/26 104
 91000/29 104
 91000/30 104
 91000/31 104
 91000/37 105
 91000/38 105
 91000/46 105
 91000/47 105
 91000/56 105
 91000/57 105
 91000/66 104
 91000/67 104
 91001/16 105
 91001/20 105
 91001/26 105
 91001/32 105
 91001/40 105
 91001/50 105
 91007/07 105
 91009/00 104
 91009/03 105
 9200900 14
 9230460 109
 9260030 115
 9401001 52
 9421 88
 9422 88
 9423 88
 9424 88
 950418 54
 960418 54
 97000/12 103
 97000/16 103
 97000/20 103
 97000/25 103
 97000/28 103
 9700316 104
 9700320 104
 9700325 104
 9700806 109
 9700808 109
 9700810 109
 9700812 109
 9700814 109
 9700816 109
 9700817 110
 9700819 109
 9700820 110
 9700825 109
 9700826 110
 9700828 110

9

9700830 110
 9700832 110
 9700834 110
 9700836 110
 9700839 110
 9700845 110
 9700850 109
 9700852 109
 9700855 109
 9700860 109
 9700875 110
 9700880 110
 97009/16 105
 97009/20 105
 97009/25 105
 9701016 104
 9701020 104
 9701025 104
 9702816 109
 9702817 110
 9702819 109
 9702820 110
 9702836 110
 9702839 110
 9702845 108
 9707 95
 9709 95
 9711 95
 9713 95
 9716 95
 9721 95
 9729 95
 9736 95
 9748 95

A

AM 0301 116
 AM 0303 116
 AM 0305 116
 AM 117 113
 AM 117/100 .. 113
 AM 117/250 .. 113
 AM 118 113
 AM 118/100 .. 113
 AM 118/250 .. 113
 AM 127 113
 AM 127/100 .. 113
 AM 128 113
 AM 200172 ... 117
 AM 37/0 112
 AM 37/1 112
 AM 37/4 112
 AM 37/6 112
 AM 9200034 . 113
 AM 9200035 . 113
 AM 9200036 . 113
 AM 9200037 . 113
 AM 9200038 . 113
 AM K0310 116
 AM L511 112
 AM L512 112
 AM L513 112

A

AM L514 112
 AM L515 112
 AM M1 112
 AM M116 114
 AM M126 114
 AM M2 112
 AM S116 115
 AM S126 115
 AM T116 115
 AM T126 115
 AM114SS 114
 AM9200026 .. 113
 AM9200027 .. 113
 AM9200028 .. 113
 AM9200029 .. 113
 AM9200030 .. 113
 AMCC1016 ... 117
 AMCC2550 ... 117
 AMCC-D-1016 117
 AMCC-D-2550 117
 AMDS16 116
 AMDS18 116
 AML512-E 112
 AMM116-C ... 114
 AMMB116 114
 AMSB116 115
 ARNO 19

B

B16221 153
 B16222 153
 B16223 154
 B16224 154
 B16226 154
 b19358 150
 B19451 155
 B250ATSA 154
 B250ATSE 154
 B40003 150
 B40004 150
 B40005 150
 B4113 153
 B4114 153
 B4115 153
 B4116 153
 BA43-06 53
 BA43-08 53
 BA43-10 53
 BA43-12 53
 BEG 150, 153, 154,
 155
 BM12 91
 BM16 91
 BM20 91
 BM20 Black .. 84
 BM20 White .. 84
 BM20LA 67, 92
 BM25 91
 BM25LA 67
 BM32 91
 BM40 91
 BM50 91

B

BM63 91
 BS115 73
 BS118 73
 BS11BEU 26
 BS21BEU 26
 BS61BEU 26

C

C16VD 79
 C16VD R 79
 C20VD 79
 C20VD R 79
 C25VD 79
 C25VD R 79
 C300B 121
 C300W 121
 C310B 120
 C310W 120
 C311B 120
 C311W 120
 C320B 121
 C320W 121
 C321B 121
 C321W 121
 C32VD 79
 C32VD R 79
 C403 119
 C404 120
 C40VD 79
 C40VD R 79
 C500 71
 C50VD 79
 C50VD R 79
 CANAL 4, 5, 6, 7, 14,
 16, 17, 18, 21,
 22, 23, 24, 25,
 26, 36, 111

CD12-11DT .. 164
 CD12-14DT .. 164
 CD12-18DT .. 164
 CD12-24DT .. 164
 CD12-30DT .. 165
 CD12-9DT 164
 CD4-11DT 164
 CD4-14DT 164
 CD4-18DT 164
 CD4-24DT 164
 CD4-30DT 164
 CD4-9DT 164
 CD7-5-11DT . 164
 CD7-5-14DT . 164
 CD7-5-18DT . 164
 CD7-5-24DT . 164
 CD7-5-30DT . 165
 CD7-5-9DT ... 164
 CGO101 51
 CLT102110R 44
 CLT102116R 44
 CLT102129R 44
 CLT102149R 44
 CON125 36
 CON125M 36

C

CON30 36
 CON30M 36
 CON70 36
 CON70M 36
 CON90 36
 CON90M 36
 CP03 111
 CP06 111
 CP08 111
 CP10 111
 CP12 111
 CP20 111
 CPN03 111
 CPN06 111
 CPN08 111
 CPN10 111
 CPN12 111
 CPN20 111

D

D006/05 157
 D006/06 157
 D006/08 157
 D010/05 157
 D010/06 157
 D010/08 157
 D010/10 157
 D016/05 157
 D016/06 157
 D016/08 157
 D016/10 157
 D025/06 157
 D025/08 157
 D025/10 157
 D035/06 157
 D035/08 157
 D035/10 157
 D035/12 157
 D050/06 157
 D050/08 157
 D050/10 157
 D050/12 157
 D070/08 157
 D070/10 157
 D070/12 157
 D070/14 157
 D095/08 157
 D095/10 157
 D095/12 157
 D095/14 157
 D120/10 157
 D120/12 157
 D120/14 157
 D150/08 157
 D150/10 157
 D150/12 157
 D150/14 158
 D185/10 158
 D185/12 158
 D185/14 158
 D240/12 158
 D240/14 158

D240/20 158
 DB06 158
 DB10 158
 DB120 158
 DB150 158
 DB16 158
 DB185 158
 DB240 158
 DB25 158
 DB35 158
 DB50 158
 DB70 158
 DB95 158
 dl 170
 DVAB1F 159
 DVAB1M 159
 DVAB2F 160
 DVAB2M 160
 DVBC 5 161
 DVBC1 159
 DVBC2 160
 DVF1/03 159
 DVF1/03.7 159
 DVF1/04 159
 DVF1/05 159
 DVF1/06 159
 DVF2/03 160
 DVF2/03.7 160
 DVF2/04 160
 DVF2/05 160
 DVF2/06 160
 DVF5/ 03 161
 DVF5/ 04 161
 DVF5/05 161
 DVF5/06 161
 DVF5/08 161
 DVFP O5 /6.3l 161
 DVFP O5 /9.5l 161
 DVFPO1/2.8F 159
 DVFPO1/4.8F 159
 DVFPO1/6.3F 159
 DVFPO2/4.8F 160
 DVFPO2/6.3F 160
 DVP 5/ 1 4 161
 DVP O 5 /6 .3 161
 DVP O 5 /6 .3 161
 DVP O 5 /9 .5 161
 DVP1/09 159
 DVP1/12 159
 DVP2/09 160
 DVP2/12 160
 DVPO1/2.8F . 159
 DVPO1/4.8F . 159
 DVPO1/4.8M 159
 DVPO1/6.3F . 159
 DVPO1/6.3M 159
 DVPO2/2.8F . 160
 DVPO2/6.3F . 160
 DVPO2/6.3M 160
 DVPOA1/6.3 . 159
 DVPOA2/6.3 . 160

D

D

DVR1/03	159
DVR1/03.7	159
DVR1/04	159
DVR1/05	159
DVR1/06	159
DVR1/08	159
DVR1/10	159
DVR1/12	159
DVR2/03	160
DVR2/03.7	160
DVR2/04	160
DVR2/05	160
DVR2/06	160
DVR2/08	160
DVR2/10	160
DVR2/12	160
DVR5/04	161
DVR5/05	161
DVR5/06	161
DVR5/08	161
DVR5/10	161
DVR5/12	161
DX 022115 ...	135
DX 022117-BC	135
DX 022125 ...	135
DX 022127-BC	135
DX 022230 ...	135
DX 440125 ...	133
DX 440150 ...	133
DX 440180 ...	133
DX 440230 ...	133
DX 803102 ...	134
DX 805102 ...	134
DX 912052 ...	134
DX 912057 ...	134
DX 912062 ...	134
DX 912067 ...	134
DX 912072 ...	134
DX 912082 ...	134
DX 912087 ...	134
DX 912092 ...	134
DX 912102 ...	134
DX 912112 ...	134
DX 912122 ...	134
DX 912132 ...	134
DX 912142 ...	134
DX 912152 ...	134
DX 912160 ...	134
DX 912170 ...	134
DX 912180 ...	135
DX 912200 ...	135
DX 912220 ...	135
DX 912250 ...	135
DX 912300 ...	135
DX 912350 ...	135

E

E10	16
E10/4	17
E11	16
E11/4	17
E12	16

E

E12/4	17
E120	60, 88
E13	16
E13/4	17
E14	16
E14/4	17
E15	16
E15/4	17
E16	16
E16/4	17
E17	16
E17/4	17
E18	16
E18/4	17
E19	16
E19/4	17
E20	16
E22	16
E23	16
E24	16
E25	16
E26	16
E26/4	17
E27	16
E28	16
E30	16
E31	16
E32	16
E32/4	17
E33	16
E34	16
E34/4	17
E35	16
E35/4	17
E36	16
E36/4	17
E37	16
E37/4	17
E38	16
E39	16
E4	16
E4/4	17
E40	16
E43	16
E48	16
E5	16
E5/4	17
E6	16
E6/4	17
E60	108
E7	16
E7/4	17
E8	16
E8/4	17
E9	16
E9/4	17
E90	12, 59, 67, 73, 74, 92, 108, 109, 110
EASY02	171
EASY04	171

E

EASY08	171
EASY12	171
EASY18	171
EC16	79
EC16 R	79
EC20	79
EC20 Black ..	81
EC20 R	79
EC20 White ..	81
EC25	79
EC25 R	79
EC32	79
EC40	79
EC50	79
EC60060EZ ..	12
EC60100EZ ..	12
EC60100GC ..	12
EC60150EZ ..	12
EC60200EZ ..	12
EC60300EZ ..	12
EC60400EZ ..	12
EC60500EZ ..	12
EC60600EZ ..	12
ECICTA20HF	80
ECICTA20HF1	80
ECICTA25HF	80
ECICTA25HF1	80
ECUT	20
ED10050	17
ED10075	18
ED12575	18
ED2525	17
ED2537	17
ED2550	17
ED2575	17
ED3737	17
ED3750	17
ED3775	18
ED5050	17
ED5075	18
ED7550	17
ED7575	18
EHF10050	18
EHF10075	18
EHF12575	18
EHF2525	18
EHF2537	18
EHF2550	18
EHF2575	18
EHF3737	18
EHF3750	18
EHF3775	18
EHF5050	18
EHF5075	18
EHF7550	18
EHF7575	18
ELDON	63
ELEKTROPLA	65, 66, 70
ERFE20G	80
ERFE25G	80
ETC120	20

F

FCV12040	24
FCV12060	24
FE12	63
FE15	63
FE25	63
FE25 Black ...	85
FE25 White ..	85
FE7	63
FE7 Black	85
FH10-BRDT .	163
FH10-DT	162
FH10-ICA10D	162
FH10-ICA6DT	162
FH10-ICA8DT	162
FH15-BRDT .	163
FH15-DT	162
FH15-ICA10D	162
FH15-ICA6DT	162
FH15-ICA8DT	162
FH20-BRDT .	163
FH20-DT	162
FH20-ICA10D	162
FH20-ICA6DT	162
FH20-ICA8DT	162
FH4-BRDT ...	163
FH4-DT	162
FH4-ICA10DT	162
FH4-ICA6DT	162
FH4-ICA8DT	162
FLX10	111
FLX20	111
FLX30	111
FLX40	111
FU12-5DT	163
FU12-5TM6D1	163
FU12-5TM8D1	163
FU20DT	163
FU20TM6DT	163
FU20TM8DT	163
FU7DT	163
FU7TM6DT ..	163
FU7TM8DT ..	163

G

G10	21
G10BEU	22
G11	21
G12	21
G13	21
G14	21
G15	21
G16	21
G16BEU	22
G17	21
G17BEU	22
G17EK	22
G18	21
G19	21
G19BEU	22
G20BEU	26
G23	21
G23BEU	22

G		G		I		J	
G24	21	GT248GB	28	IWAP2012Blac	32	jsl	3, 4, 26, 29, 30,
G26	21	GT248IB	27	IWAP4017B ..	30		31, 32, 33, 39,
G27	21	GT248LB	27	IWAP4017Blac	32		48, 49, 61, 62,
G27BEU	22	GT248TB	28	IWGT10054B	4		63, 64, 65, 67,
G28	21	Guest05	111	IWGT10054Bl:	4		71, 73, 74, 75,
G30	21	Guest10	111	IWGT2012B ..	30		76, 77, 78, 79,
G30BEU	22	Guest20	111	IWGT2012Blac	32		80, 81, 82, 83,
G31	21	Guest30	111	IWGT4017B ..	30		84, 85, 91, 92,
G31BEU	22	Guest50	111	IWGT4017Blac	32		95, 96, 98, 99,
G31EK	22			IWGU100	4		100, 101, 102,
G31EKBEU ..	23	H		IWGU100Blac	4		103, 118, 119
G31KBEU	23	HB0050	89	IWGU2012B ..	30	K	
G32	21	HB0060	89	IWGU2012Blac	32	KCP00S	171
G33	21	HB0070	89	IWGU4017B ..	30	KIT-B40004 ..	151
G33BEU	22	HB0080	89	IWGU4017Blac	32	KIT-B40004-SI	151
G35	21	HB0100	89	IWS10040B ..	4	KIT-FILTREVE	151
G37	21	HB0120	89	IWS10040Blac	4	KKD	60, 88, 108
G38	21	HB0150	90	IWTT10054B	4	KOPOS	33, 34, 35
G39	21	HB0180	90	IWTT10054Bl:	4	KP64-50-2LD	73
G4	21	HF	74	IWTT2012B ..	30	KP64-50-3LD	73
G40	21	HTC18S	171	IWTT2012Blac	32	KP64-50-4LD	73
G40BEU	22	HU202212	97	IWTT2012Blac	32	KP64-50-5LD	73
G40EK	22	HU202216	97	IWTT4017B ..	30	KP64-60LD ..	73
G40EKBEU ..	23	HU202220	97	IWTT4017Blac	32	KPZ1PO	74
G41BEU	26	HU202225	97	IZ10/2F/54 ..	156	KT3001	130
G43	21	HU202232	97	IZ10/3F/54 ..	156	KT3002-3204	130
G44BEU	26	HU202240	97	IZ16/2F/54 ..	156	KT3204	130
G45BEU	26	HU202250	97	IZ16/3F/54 ..	156	KTA00S	172
G48	21	HU202263	97	IZ16/4F/56 ..	156		
G48BEU	22			IZ16/4FN/54 ..	156	L	
G4BEU	22	I		IZS10/3F/54 ..	156	LD075A	7
G4EK	22	IW10054B	3	IZS16/2F/54 ..	156	LD075E	6
G5	21	IW10054BEK	3	IZS16/3F/54 ..	156	LD075I	6
G50	21	IW10054Black	3	IZS16/4F/56 ..	156	LD075L	6
G50BEU	22	IW10054BLH	3			LD075T	7
G50EK	22	IW10054EKBl:	3	J		LD105E	6
G50EKBEU ..	23	IW10054LHBl:	3	J100B	62	LD105I	6
G50KBEU	23	IW2012.5B	29	J100BF	67	LD105L	6
G6	21	IW2012.5Blac	31	J100L	62	LD105T	7
G6BEU	22	IW2012.5LHBl	33	J100S	61	LD125E	6
G7	21	IW20125LH ..	33	J100S Black ..	84	LD125I	6
G8	21	IW2020LH	33	J100S White ..	84	LD125L	6
G8BEU	22	IW4017B	29	J100SC	61	LD125T	7
G9	21	IW4017Black	31	J100SF	67	LD127A	7
G9BEU	22	IW4017LH	33	J1207PAD	26	LDJ01	169
GCOP025	23	IW4017LHBlac	33	J1602	67	Legrand	7, 8
GCOP040	23	IW6040LH	33	J160B	62	LG76561	8
GCOP060	23	IWAE10054B	4	J160BF	67	LG77142	8
GCOP080	23	IWAE10054Bl:	4	J160L	62	LG77301	7
GCOP100	23	IWAE2012B ..	30	J1610PAD	26	LG77302	7
GCOP100BEL	24	IWAE2012Blac	32	J200B	62	LG77303	7
GCOP120	23	IWAE4017B ..	30	J200BF	67	LG77304	7
GCOP120BEL	24	IWAE4017Blac	32	J200L	62	LHD2010HF ..	33
GCOP150	23	IWAI10054B ..	4	J2021	67	LHD2020HF ..	33
GCOP150BEL	24	IWAI10054Blac	4	J402Z	67	LHD4020HF ..	33
GCOP200	23	IWAI2012B	30	J80B	62	LHD4040HF ..	33
GCOP200BEL	24	IWAI2012Blac	32	J80L	62	LHD8623HF ..	34
GT100A	7	IWAI4017B	30	JMV	50, 103, 104, 105, 109, 113	LHD8624HF ..	35
GT16A	28	IWAI4017Blac	32			LHD8625HF ..	34
GT248AB	28	IWAP10054B	4			LHD8626HF ..	34
GT248EB	27	IWAP10054Bl:	4			LHD8633HF ..	34
		IWAP2012B ..	30			LHD8634HF ..	35

L

LHD8635HF . 34
 LHD8636HF . 34
 LHD8643HF . 34
 LHD8644HF . 35
 LHD8645HF . 34
 LHD8646HF . 34
 LHD8923HF . 34
 LHD8924HF . 35
 LHD8925HF . 34
 LHD8926HF . 34
 LOCKC-M 70
 LOCKD-M 71
 LSOH 3, 4, 18, 19, 30,
 32, 33, 47, 48,
 49, 61, 62, 63,
 64, 65, 66, 67,
 68, 69, 71, 73,
 74, 75, 76, 77,
 78, 79, 80, 81,
 82, 83, 84, 85,
 91, 92, 93, 94,
 95, 96, 98, 99,
 100, 101, 102,
 103, 106, 107,
 118, 119, 151

M

M001CS 64
 M002CS 64
 M003CS 64
 M005CS 64
 MARLANVIL . 64
 MCLIC 13
 ME1216 93
 ME1620 93
 ME2025 93
 ME2532 93
 ME3240 93
 MET22102R . 43
 MET22105R . 43
 MET22110R . 43
 MET22111R . 43
 MET22112R . 43
 MET22123R . 43
 MET22126R . 43
 MET22140R . 43
 MET22534R . 43
 MET32102R . 44
 MET32105R . 44
 MET32110R . 44
 MET32111R . 44
 MET32112R . 44
 MET32123R . 44
 MET32126R . 44
 MET32140R . 44
 MET32326R . 44
 MET32534R . 44
 MF 14, 38, 42, 50,
 54, 55, 56, 57,
 103, 112, 113,
 114, 115, 116,
 117
 MF10025 42
 MF10025B 42
 MF111 43

M

MF112 43
 MF116890 42
 MF116890B .. 42
 MF15025 42
 MF15025B 42
 MF15035 42
 MF15035B 42
 MF15045 42
 MF15045B 42
 MF20025 42
 MF20025B 42
 MF20048 42
 MF20048B 42
 MF242 65
 MF30036 42
 MF30036B 42
 MF30048 42
 MF30048B 42
 MF30076 42
 MF30076B 42
 MF37048 42
 MF37048B 42
 MF37076 42
 MF37076B 42
 MF53076 42
 MF53076B 42
 MF53090 42
 MF53090B 42
 MF76090 42
 MF76090B 42
 MFBOX01 123
 MFM46 123
 MFPS17 123
 MFR253G25 . 122
 MFR403G25 . 122
 MFVS10 122
 MFVS15 122
 MFVS20 122
 MFVS25 122
 MFVS30 122
 MFVS40 122
 MFVS50 122
 MG 1010630 52
 MG 1010640 52
 MG 1010850 52
 MG 1011060 . 52
 MG 1011270 . 52
 MG 1011470 . 52
 MG 1050060 52
 MG 1050080 52
 MG 1050100 52
 MG 1050120 52
 MG 1380533 52
 MG 1380534 52
 MGRP121209 63
 MGRP122209 63
 MGRP161609 63
 MGRP162609 63
 MGRP163609 63
 MGRP165609 63
 MGRP252612 63

M

MGRP254012 63
 MGRP414012 63
 MIB16 63
 MIB21 63
 MIB29 63
 MIBR1620 80
 MIBR1620 Bla 82
 MIBR1620 Wh 82
 MJB112 169
 MJB113 169
 MJB215 169
 MJB222 169
 MJB332 169
 MP0030 167
 MP0100 167
 MP1000 167
 MP2200 167
 MPONE GEL 167
 MR1612 94
 MR2012 94
 MR2016 94
 MR2512 94
 MR2516 94
 MR2520 94
 MR3212 94
 MR3216 94
 MR3220 94
 MR3225 94
 MR4016 94
 MR4020 94
 MR4025 94
 MR4032 94
 MR5020 94
 MR5025 94
 MR5032 94
 MR5040 94
 MR6325 94
 MR6332 94
 MR6340 94
 MR6350 94

N

N12-C 68
 N12-D 69
 N18-C 68
 N24-C 68
 N24-D 69
 N2x18-C 68
 N36-C 68
 N36-D 69
 N3x18-C 68
 N48-C 68
 N48-D 69
 N4-C 68
 N4-D 69
 N4x18-C 68
 N8-C 68
 N8-D 69
 NEW 3, 30, 31, 70,
 106, 107, 132,
 166
 NSET-C-D 70

N

NVIS-C-D 69

O

OL70211 49
 OL70212 49
 OL70213 49
 OL70214 49
 OL70215 49
 OL70216 49
 OL70217 49
 OL70218 49
 OMRL05-A7 . 92
 ortac 91, 92, 93, 95

P

PARABOND 6 170
 PARABOND 6 170
 PARABOND 6 170
 PARABOND 7 170
 PARABOND 7 170
 PARABOND 8 170
 PARABOND 8 170
 PARACOL PU 170
 PARAFOAM F 170
 PARAFOAM N 170
 PARAFOAM R 170
 PARAFOAM.C 170
 PARASILICO \ 170
 PC0015 58
 PC0018 58
 PC0022 58
 PC0028 58
 PC0035 58
 PC0042 58
 PC0048 58
 PC0054 58
 PC0060 58
 PC0064 58
 PC0090 58
 PC0110 58
 PC1075 58
 PC1100 58
 PC1115 58
 PC1125 58
 PC1133 58
 PC1140 58
 PC1150 58
 PC1160 58
 PD15ZF4 14
 PD32ZF6 14
 PD35CZ 14
 PD35CZF6 ... 14
 PD35Z 14
 PD35ZF6 14
 pgb 88, 89
 PGB0525015 . 88
 PGB0618016 . 88
 PGB0625015 . 88
 PGB0824020 . 88
 PGB0830015 . 88
 PGB1030025 . 88
 PGB934-806 | 88

P

PGB934-808 | 88
 PGB934-810 | 88
 PGBZ40020V 89
 PGBZ40025V 89
 PGBZ40030V 89
 PGBZ40035V 89
 PGBZ40040V 89
 PGBZ40045V 89
 PGBZ45040V 89
 PGBZ45045V 89
 PGBZ45050V 89
 PGBZ45060V 89
 PGBZ45080V 89
 PGBZ50050V 89
 PGBZ50090V 89
 PGBZ60040V 89
 PICSHARK68(169
 PICSHARK68(169
 PICSHARK68(169
 PICSHARK68(169
 PICSHARK68(169
 PICSHARK68(169
 PIN003-CTTN 45
 PIN005 47
 PIN006-CTTS 45
 PM12 91
 PM16 91
 PM20 91
 PM25 91
 PM32 91
 PM40 91
 PM50 91
 PM63 91
 PROMOKITH/ 152
 PROMOKITL 152
 PRRIV1 20
 PRRIV2 20
 PSTB-4 107
 PSTB-7 107
 PTR 19

R

RF 170
 RH18S 70
 RH36/2S 70
 RH54/3S 70
 RH72/4S 70
 RIV1 20
 RIV2 20
 RS150 167
 RS1650 167
 RS300 167
 RS400 167
 RS550 167
 RS650 167
 RT 100087 ... 146
 RT 100090 ... 146
 RT 10014 146
 RT 20116 146
 RT 20119 146
 RT 20273 147
 RT 20274 147

R

RT 20303 146

S

S1 24
 S2 24
 S4 24
 S5 24
 SAE160 6
 SAI160 6
 SAI160BEU .. 34
 SAP160 6
 SAPI 40, 41, 43, 44,
 45, 46, 47, 51,
 53
 SB17-11DT ... 164
 SCO45 5
 SDK3 38
 SDK5 38
 SDK8 38
 SDKF2TR-AN 38
 SDKF3TR-AN 38
 SDKF5TR-AN 38
 SEL.2.202T .. 47
 SEL101 46
 SEL10202R .. 44
 SEL10210R .. 44
 SEL10223R .. 44
 SEL10425R .. 44
 SEL11202R .. 44
 SEL11210R .. 44
 SEL11223R .. 44
 SEL11425R .. 44
 SEL12202R .. 44
 SEL12210R .. 44
 SEL12223R .. 44
 SEL12425R .. 44
 SEL14202R .. 44
 SEL14210R .. 44
 SEL14223R .. 45
 SEL14425R .. 45
 SEL2142 40
 SEL2143 40
 SEL2144 40
 SEL2155 40
 SEL2201 40
 SEL2202 40
 SEL2203 40
 SEL2204 40
 SEL2205 40
 SEL2210 40
 SEL2211 40
 SEL2212 40
 SEL2214 40
 SEL2216 40
 SEL2220 40
 SEL2221 40
 SEL2222 40
 SEL2223 40
 SEL2224 40
 SEL2401 46
 SEL2402 46
 SEL2403 46

S

SEL2425 40
 SEL2426 40
 SEL2427 40
 SEL2428 40
 SEL2429 40
 SEL2430 40
 SEL2431 40
 SEL2432 40
 SEL2433 40
 SEL2434 40
 SEL2435 40
 SEL2436 40
 SEL2438 40
 SEL2441 40
 SEL2447 40
 SEL2450 40
 SEL2451 40
 SEL2452 40
 SEL2453 40
 SEL2501 46
 SEL2502 46
 SEL3142 41
 SEL3143 41
 SEL3144 41
 SEL3150 41
 SEL3155 41
 SEL3201 41
 SEL3202 41
 SEL3203 41
 SEL3204 41
 SEL3205 41
 SEL3210 41
 SEL3211 41
 SEL3212 41
 SEL3214 41
 SEL3215 40
 SEL3216 41
 SEL3220 41
 SEL3221 41
 SEL3222 41
 SEL3223 41
 SEL3224 41
 SEL3320 47
 SEL3321 47
 SEL3322 47
 SEL3323 47
 SEL3324 47
 SEL3425 41
 SEL3426 41
 SEL3427 41
 SEL3428 41
 SEL3429 41
 SEL3430 41
 SEL3431 41
 SEL3432 41
 SEL3433 41
 SEL3434 41
 SEL3436 41
 SEL3437 40
 SEL3438 41
 SEL3441 41

S

SEL3447 41
 SEL3451 41
 SEL3452 41
 SEL3453 41
 SEL712006 .. 51
 SEL712008 .. 51
 SEL712010 .. 51
 SEL712012 .. 51
 SELCXP102 .. 53
 SELCXP104 .. 53
 SELCXP106 .. 53
 SELRXO101 .. 51
 SELRXO102 .. 51
 SGAC 5
 SGCO 5
 SHARK150 ... 168
 SHARK306 ... 168
 SHARK325 ... 168
 SHARK506 ... 168
 SHARK506W 168
 SHARK516 ... 168
 SHARK516Y 168
 SHARK525W 168
 SHARK6801A 169
 SHARK6801B 169
 SHARK6801C 169
 SHARK6801D 169
 SHARK6802A 169
 SHARK6803A 169
 SILAM85-1 BL 170
 SILAM85-1 TF 170
 SILAM85-1 WI 170
 SILSANITAIR 170
 sinard 162, 163, 164
 SN25H07R3G 122
 SN25H07R3G 122
 SN25H07R5G 122
 SN25H07R5G 122
 SOC10SG 12
 SOC15SG 12
 SOC20SG 12
 SOC30SG 12
 SOPC10SG .. 12
 SOPC15SG .. 12
 SOPC20SG .. 12
 SOPC30SG .. 12
 Spirado 132
 Spiratrek 132
 SR 22305501 140
 SR 22305520 140
 SR 22305529 140
 SR 22305538 140
 SR 22305547 140
 SR 22305556 140
 SR 22305565 140
 SR 22305574 140
 SR 22305583 140
 SR 22305592 140
 SR 22305601 140
 SR 22305620 140

S

SR 22305629 140
 SR 22305638 140
 SR 22305647 140
 SR 22305656 140
 SR 22305665 140
 SR 22305674 140
 SR 22305683 140
 SR 22305692 140
 SR 22305701 140
 SR 22305710 140
 SR 22305719 140
 SR 22305728 140
 SR 22305737 140
 SR 22315019 141
 SR 22315025 141
 SR 22400100 144
 SR 22400120 144
 SR 22400154 144
 SR 22400185 144
 SR 23120540 143
 SR 23140340 143
 SR 23140540 143
 SR 23150340 143
 SR 23160540 143
 SR 23160940 143
 SR 23180540 143
 SR 23180940 143
 SR 23200320 143
 SR 23200520 143
 SR 23200920 143
 SR 23220320 143
 SR 23220520 143
 SR 23220920 143
 SR 23240320 143
 SR 23240520 143
 SR 23250320 143
 SR 23250520 143
 SR 23250920 143
 SR 23251320 143
 SR 23260520 143
 SR 23280370 143
 SR 23280570 143
 SR 23280670 143
 SR 23280920 143
 SR 23281320 143
 SR 23300370 143
 SR 23300570 143
 SR 23300920 143
 SR 23320370 143
 SR 23320570 143
 SR 23320920 143
 SR 23321320 143
 SR 23350570 143
 SR 23350670 143
 SR 23350920 143
 SR 23351320 143
 SR 23380570 143
 SR 23400570 143
 SR 23400920 143
 SR 23401320 144
 SR 23450570 143

S

SR 23500570 143
 SR 23520570 143
 SR 24050111 141
 SR 24050161 141
 SR 24050261 141
 SR 24060111 141
 SR 24060161 141
 SR 24060211 141
 SR 24060261 141
 SR 24060311 142
 SR 24065161 141
 SR 24065211 141
 SR 24065261 141
 SR 24065311 142
 SR 24080111 141
 SR 24080161 141
 SR 24080211 141
 SR 24080261 141
 SR 24080311 142
 SR 24080361 142
 SR 24080461 142
 SR 24100161 141
 SR 24100211 141
 SR 24100261 141
 SR 24100311 142
 SR 24100361 142
 SR 24100461 142
 SR 24100601 142
 SR 24100951 142
 SR 24120161 141
 SR 24120211 141
 SR 24120261 141
 SR 24120311 142
 SR 24120461 142
 SR 24120601 142
 SR 24120951 142
 SR 24140161 141
 SR 24140211 141
 SR 24140261 141
 SR 24140311 142
 SR 24140461 142
 SR 24140601 142
 SR 24140951 142
 SR 24150261 142
 SR 24160161 141
 SR 24160211 141
 SR 24160261 142
 SR 24160311 142
 SR 24160461 142
 SR 24160601 142
 SR 24160951 142
 SR 24180251 141
 SR 24180461 142
 SR 24180951 142
 SR 24200251 141
 SR 24200461 142
 SR 24200951 142
 SR 24220251 141
 SR 24220461 142
 SR 24240251 141
 SR 24240461 142

S

SR 24280461 142
 SR 24300251 141
 SR 24300451 142
 SR 24320451 142
 SR 26001005 144
 SR 26001018 144
 SR 26802008 145
 SR 26802010 145
 SR 26802012 145
 SR 26802014 145
 SR 26802016 145
 SR 26802018 145
 SR 26802020 145
 SR 26802022 145
 SR 26802024 145
 SR 26802025 145
 SR 26802028 145
 SR 26802030 145
 SR 26802032 145
 SR 26802035 145
 SR 26802038 145
 SR 26802040 145
 SR 26814408 145
 SR 26814410 145
 SR 26814412 145
 SR 26814414 145
 SR 26814418 145
 SR 26814420 145
 SR 26814422 145
 SR 26814428 145
 SR 26814430 145
 SR 26814435 145
 SR 26825000 145
 SR 27001600 136
 SR 27001900 136
 SR 27002000 136
 SR 27002200 136
 SR 27002500 136
 SR 27002700 136
 SR 27002900 136
 SR 27003000 136
 SR 27003200 136
 SR 27003500 136
 SR 27003800 136
 SR 27004000 136
 SR 27004100 136
 SR 27004300 136
 SR 27004400 136
 SR 27004600 136
 SR 27004800 136
 SR 27005100 136
 SR 27005200 136
 SR 27005400 136
 SR 27005700 136
 SR 27005800 136
 SR 27006000 136
 SR 27006400 136
 SR 27006700 136
 SR 27006800 136
 SR 27007000 136
 SR 27007300 136

S

SR 27007400 136
 SR 27007600 136
 SR 27007900 136
 SR 27008300 136
 SR 27008600 136
 SR 27008900 136
 SR 27009200 136
 SR 27009500 136
 SR 27009800 136
 SR 27010200 136
 SR 27010500 136
 SR 27010800 136
 SR 27011100 136
 SR 27011400 136
 SR 27012100 137
 SR 27012700 137
 SR 27013300 137
 SR 27014000 137
 SR 27014600 137
 SR 27015200 137
 SR 28080014 137
 SR 28080016 137
 SR 28080017 137
 SR 28080019 137
 SR 28080020 137
 SR 28080021 137
 SR 28080022 137
 SR 28080024 137
 SR 28080025 137
 SR 28080027 137
 SR 28080029 137
 SR 28080030 137
 SR 28080032 137
 SR 28080033 137
 SR 28080035 137
 SR 28080037 137
 SR 28080038 137
 SR 28080040 137
 SR 28080041 137
 SR 28080043 137
 SR 28080044 137
 SR 28080046 137
 SR 28080048 137
 SR 28080051 137
 SR 28080052 137
 SR 28080054 137
 SR 28080057 137
 SR 28080059 137
 SR 28080060 137
 SR 28080064 138
 SR 28080065 138
 SR 28080067 138
 SR 28080068 138
 SR 28080070 138
 SR 28080073 138
 SR 28080076 138
 SR 28080079 138
 SR 28080083 138
 SR 28080086 138
 SR 28080089 138
 SR 28080092 138

S

SR 28080095 138
 SR 28080098 138
 SR 28080102 138
 SR 28080105 138
 SR 28080108 138
 SR 28080111 138
 SR 28080114 138
 SR 28080121 138
 SR 28080127 138
 SR 28080140 138
 SR 28080152 138
 SR 29555020 138
 SR 29555022 138
 SR 29555025 138
 SR 29555029 138
 SR 29555030 138
 SR 29555032 138
 SR 29555035 138
 SR 29555038 138
 SR 29555040 138
 SR 29555044 138
 SR 29555050 138
 SR 29555051 138
 SR 29555054 139
 SR 29555057 139
 SR 29555060 139
 SR 29555063 139
 SR 29555065 139
 SR 29555067 139
 SR 29555068 139
 SR 29555070 139
 SR 29555073 139
 SR 29555076 139
 SR 29555079 139
 SR 29555080 139
 SR 29555082 139
 SR 29555083 139
 SR 29555086 139
 SR 29555089 139
 SR 29555092 139
 SR 29555102 139
 SR 29555105 139
 SR 29555108 139
 SR 29555111 139
 SR 29555114 139
 SR 29555121 139
 SR 29555125 139
 SR 29555127 139
 SR 29555133 139
 SR 29555140 139
 SR 29555152 139
 SR 29555165 139
 SR 29555185 139
 SR 29609524 140
 SR 29609527 140
 SR 29609605 140
 SR 29609610 140
 SSCT1 45
 SSCT2 45
 SSCT3 45
 SSCT4 45

S

SSCT5 45
 SSCT6 45
 SSCT7 45
 ST16 106
 ST20 106
 ST25 106
 ST32 106
 ST40 106
 STC16 106
 STC20 106
 STC25 106
 STC32 106
 STC40 106
 STT160 7
 SYM70250 ... 59
 SYS1051 4
 SYS1252 4
 SYS1603 4
 SYS751 4

T

Tehnoplast 68, 69, 72
 TERMINAL ... 38
 TP151920BK 37
 TP151920BL 37
 TP151920BN 37
 TP151920GR 37
 TP151920GRN 37
 TP151920GY 37
 TP151920RD 37
 TP151920WT 37
 TP151920YL 37
 TPQSM32 72
 TR06 19
 TR08 19
 TR10 19
 TR10006 59
 TR10008 59
 TR10010 59
 TR10012 59
 TR20006 59
 TR20008 59
 TR20010 59
 TR20012 59
 TR30006 59
 TR30008 59
 TR30010 59
 TR30012 59

U

U12-C 68
 U18-C 68
 U24-C 68
 U2x18-C 68
 U36-C 68
 U3x18-C 68
 U407 78
 U407 R 78
 U408 78
 U408 Black ... 82
 U408 R 78
 U408 White .. 82

U

U409 78
 U409 Black ... 82
 U409 R 78
 U410 78
 U410 R 78
 U411 78
 U411 R 78
 U412 78
 U412 R 78
 U413R 78
 U4-C 68
 U8-C 68
 unistrut 15
 univoltd 78, 80
 UNP1000TX3 15
 UNP1000TX6 15
 UNP3300T10> 15
 UNP3300T10> 15

V

V6H100100 .. 19
 V6H10060 19
 V6H10080 19
 V6H2525 19
 V6H4025 19
 V6H4040 19
 V6H4060 19
 V6H4080 19
 V6H60100 19
 V6H60120 19
 V6H6025 19
 V6H6040 19
 V6H6060 19
 V6H6080 19
 V6H80100 ... 19
 V6H80120 ... 19
 V6H8025 19
 V6H8040 19
 V6H8060 19
 V6H8080 19
 valdinox 12, 13
 VD16 76
 VD16 FLH ... 77
 VD16 LLH 76
 VD16 MLH ... 77
 VD16 R 76
 VD16HFIRM- 78
 VD20 76
 VD20 Black .. 81
 VD20 FLH 77
 VD20 LLH 76
 VD20 LLHBLA 76, 81
 VD20 MLH 77
 VD20 R 76
 VD20 White .. 81
 VD20HFIRM- 78
 VD20HFPRM 78
 VD25 76
 VD25 LH 77
 VD25 LLH 76
 VD25 R 76
 VD25HFIRM- 78

V

VD32 76
 VD32 LH 77
 VD32 LLH 76
 VD32 R 76
 VD40 76
 VD40 LH 77
 VD40 R 76
 VD50 76
 VD50 LH 77
 VD50 R 76
 VD63 LH 77
 VD63R 76
 VEN-AMY005- 148
 VEN-AMY005- 148
 VEN-AMY005- 148
 VEN-AMY005- 148
 VEN-AMY005- 148
 VEN-AMY005- 148
 VEN-AMY005- 148
 VEN-AMY005- 148
 VEN-AMY005- 148
 VEN-AMY005- 149
 VEN-AMY005- 148
 VEN-AMY005- 148
 VEN-AMY005- 149
 VEN-AMY005- 149
 VEN-AMY005- 149
 VEN-AMY005- 149
 VEN-AMY006- 148
 VEN-AMY006- 148
 VEN-AMY006- 148
 VEN-AMY006- 148
 VEN-AMY006- 148
 VEN-AMY006- 148
 VEN-AMY006- 149
 VEN-AMY006- 149
 VEN-AMY006- 149
 VEN-AMY006- 149
 VEN-AMY006- 148
 VEN-AMY006- 148
 VEN-AMY006- 149
 VEN-AMY006- 149
 VEN-AMY006- 149
 VK 9, 11
 VKCOMEGAC 11
 VKCOMEGAC 11
 VKCOMEGAC 11
 VKCOMEGAC 11
 VKCOMEGAC 11
 VKCOMEGAC 11
 VKCOMEGAC 11
 VKCOMEGAC 11
 VKCOMEGAC 11
 VKCOMEGAC 11
 VKCOMEGAC 11
 VKCOMEGAC 11
 VKCOMEGAC 11
 VKKBSCL 60. 9
 VKKBSCL 60.: 9
 VKKBSCL 60.: 9
 VKKBSCL 60.: 9
 VKKBSCL60.1 9
 VKKBSCL60.1 9

V

VKKBSCL60.2	9
VKKBSCL60.3	9
VKKBSI 60.15	9
VKKBSI 60.20	9
VKKBSI 60.25	9
VKKBSI 60.30	9
VKKBSI 60.40	9
VKKBSI60.10C	9
VKKBSI60.10C	9
VKKBSI60.20C	9
VKOBZ130.07	10
VKOBZ130.10	10
VKOBZ130.15	10
VKOBZ130.20	10
VKOBZ130.25	10
VKOBZ130.30	10
VKOBZ130.40	10
VKOBZ180.07	10
VKOBZ180.10	10
VKOBZ180.15	10
VKOBZ180.20	10
VKOBZ180.25	10
VKOBZ180.30	10
VKOBZ180.40	10
VKVFUL35.30	11
VKVFUL35.35	11
VKVFUL60.10	11
VKVFUL60.15	11
VKVFUL60.20	11
VKVFUL60.40	11
VKVFUL60.50	11
VKWKSS100	10
VKWKSS150	10
VKWKSS200	10
VKWKSS250	10
VKWKSS300	10
VKWKSS400	10
VKWKSS500	10
VKWKSS600	10
VS03XLDE ...	166
VS05XLE	166
VS120E	166
VS250E	166
VS500E	166

W

W10	126
W10.1	126
W100	126
W1000	125
W11850200 ..	166
W16	127
W25	128
W30	127
W300	128
W400	129
W4-16	124
W50	124
W500	129
W8-27	124
WAB05200 ...	20
WBLI13	127

W

WBLI28H4	125
WBLI3SOLAR	129
WBLI5	128
WBLI7SOLAR	129
WBLIS428	125

Z

Z102F	156
Z103F	156
Z162F	156
Z163F	156
Z164F	156
ZBFB	25
ZBFG	25
ZBFG-M	25
ZS102F	156
ZS103F	156
ZS162F	156
ZS163F	156
ZS164F	156



ONZE GEGEVENS NOS COORDONNÉES

ToFix bvba

Deurnsebaan 46
2170 Merksem

Telefoonnummer

Numéro de téléphone
+32 3 644 87 87

Emailadres

Adresse e-mail
sales@tofix.be

Michael Hendrickx

G: +32 477 37 00 70
T: +32 3 644 87 87
E: mh@tofix.be

Philip Maervoet

G: +32 472 17 34 51
T: +32 3 644 87 87
E: pm@tofix.be

Inge Van den Broeck

G: +32 493 85 96 20
T: +32 3 644 87 87
E: iv@tofix.be